



**CÔNG TY CP NHÔM VIỆT PHÁP SHAL  
NHÀ MÁY NHÔM VIỆT PHÁP**

Địa chỉ: Lô KT, KCN Phúc Sơn, Đường Trần Nhân Tông, Thành phố Ninh Bình, Việt Nam  
Điện thoại: 024.8587 7979 / 0915156156 - <http://nhomvietphap.biz>

**HỆ THỐNG  
NHÔM**

**CỬA SỔ XINGFA  
55**

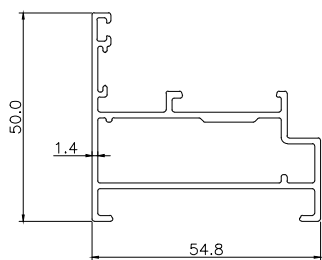

**C3318**

W = 0,845 Kg/m

T = 1,4 mm

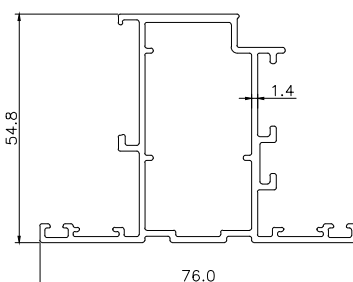

**C3202**

W = 1,088 Kg/m

T = 1,4 mm

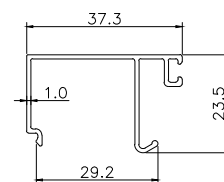

**C3295**

W = 0,271 Kg/m

T = 1,0 mm

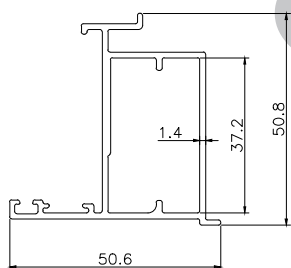

**C3208**

W = 0,760 Kg/m

T = 1,4 mm

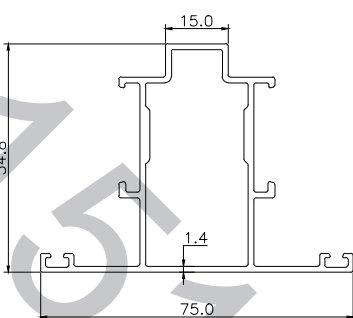

**C3313**

W = 1,002 Kg/m

T = 1,4 mm

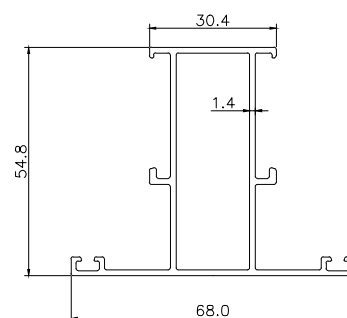

**C3204**

W = 0,880 Kg/m

T = 1,4 mm

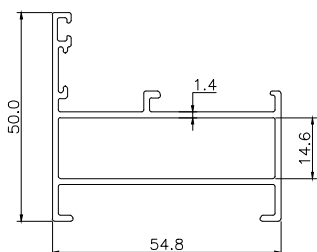

**C3209**

W = 0,802 Kg/m

T = 1,4 mm

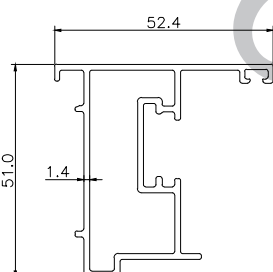

**C3033**

W = 0,825 Kg/m

T = 1,4 mm

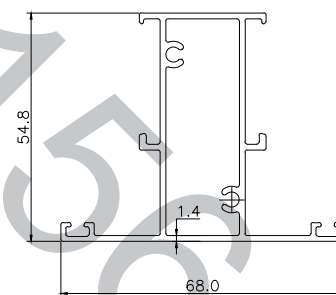

**C3203**

W = 0,950 Kg/m

T = 1,4 mm

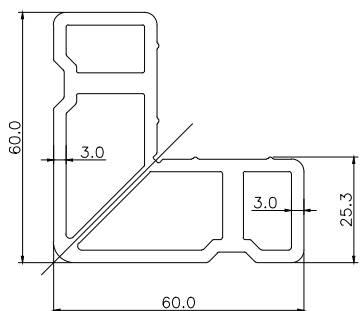

**C1697**

W = 2,437 Kg/m

T = 3,0 mm

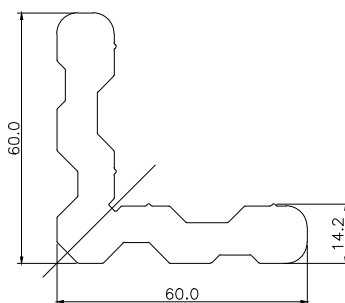

**1687**

W = 3,134 Kg/m

T = 14,2 mm

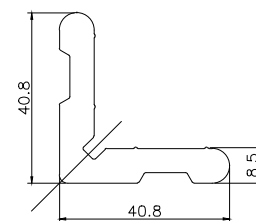

**107**

W = 1,414 Kg/m

T = 8,5 mm



**CÔNG TY CP NHÔM VIỆT PHÁP SHAL**  
**NHÀ MÁY NHÔM VIỆT PHÁP**  
 Địa chỉ: Lô KT, KCN Phúc Sơn, Đường Trần Nhân Tông, Thành phố Ninh Bình, Việt Nam  
 Điện thoại : 024.8587 7979 / 0915156156 - http://nhomvietphap.biz

**HỆ THỐNG NHÔM**

**CỬA SỔ XINGFA 55**

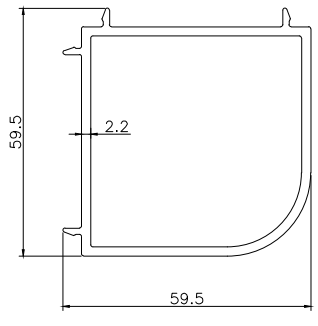
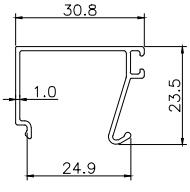
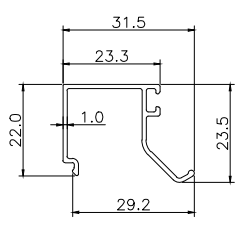

**C3286**

W = 0,223 Kg/m  
T = 1,0 mm

**C3296**

W = 0,237 Kg/m  
T = 1,0 mm

**C3326**

W = 1,275 Kg/m  
T = 2,2 mm

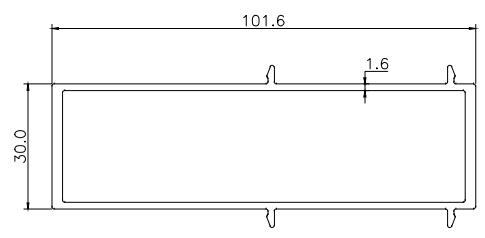
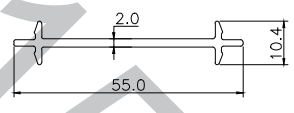
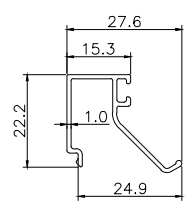

**C3291**

W = 0,206 Kg/m  
T = 1,0 mm

**C3300**

W = 0,347 Kg/m  
T = 2,0 mm

**C3310**

W = 1.308 Kg/m  
T = 1.6 mm



**CÔNG TY CP NHÔM VIỆT PHÁP SHAL  
NHÀ MÁY NHÔM VIỆT PHÁP**

Địa chỉ: Lô KT, KCN Phúc Sơn, Đường Trần Nhân Tông, Thành phố Ninh Bình, Việt Nam  
Điện thoại: 024.8587 7979 / 0915156156 - <http://nhomvietphap.biz>

**HỆ THỐNG  
NHÔM**

**CỬA SỔ XINGFA 55  
- 1,2**

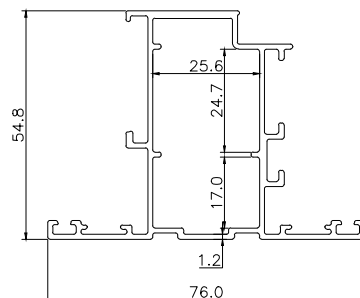
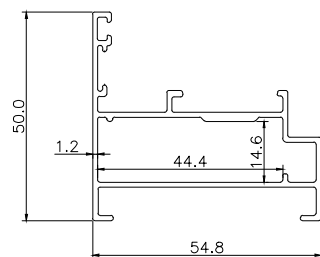
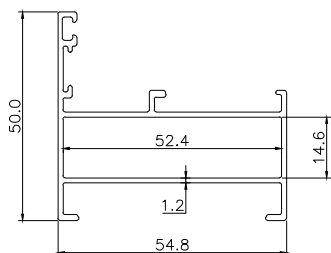

**C3209B**

W = 0,707 kg/m  
T = 1,2 mm

**C3318B**

W = 0,748 kg/m  
T = 1,2 mm

**C3202B**

W = 0,972 kg/m  
T = 1,2 mm

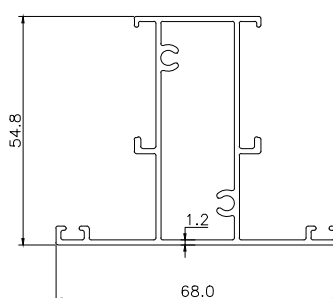
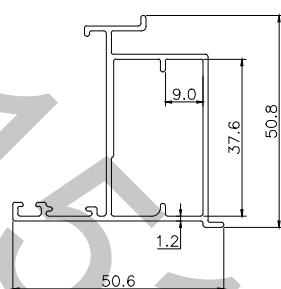
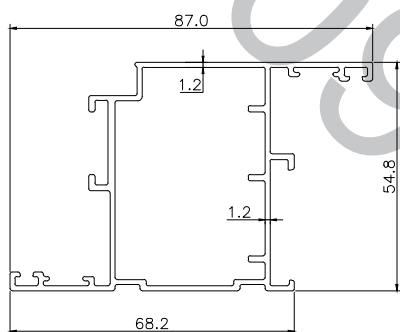

**C3332B**

W = 1.035 kg/m  
T = 1,2 mm

**C3208B**

W = 0,672 kg/m  
T = 1,2 mm

**C3203B**

W = 0,849 kg/m  
T = 1,2 mm

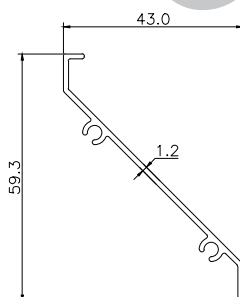
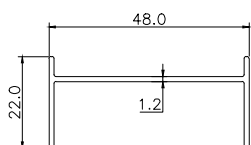

**E1283**

W = 0,290 kg/m  
T = 1,2 mm

**E192**

W = 0,316 kg/m  
T = 1,2 mm



**CÔNG TY CP NHÔM VIỆT PHÁP SHAL**  
**NHÀ MÁY NHÔM VIỆT PHÁP**

Địa chỉ: Lô KT, KCN Phúc Sơn, Đường Trần Nhân Tông, Thành phố Ninh Bình, Việt Nam  
Điện thoại: 024.8587 7979 / 0915156156 - http://nhomvietphap.biz

**HỆ THỐNG**  
**NHÔM**

**CỬA ĐI XINGFA 55**

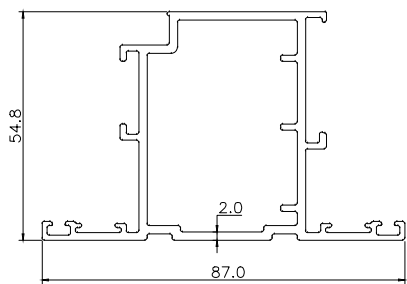

**C3303**

W = 1,441 Kg/m

T = 2,0 mm

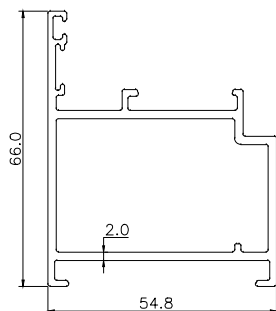

**C3328**

W = 1,257 Kg/m

T = 2,0 mm

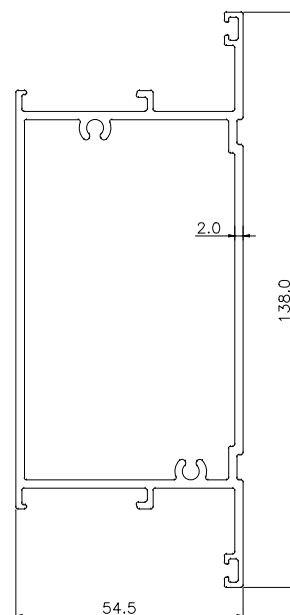

**C3304**

W = 2,023 Kg/m

T = 2,0 mm

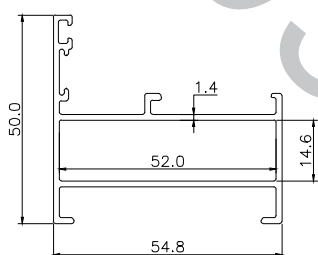

**C3209**

W = 0,802 Kg/m

T = 1,4 mm

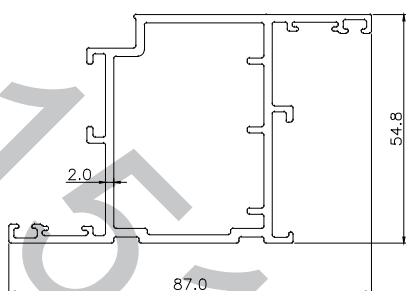

**C3332**

W = 1,441 Kg/m

T = 2,0 mm

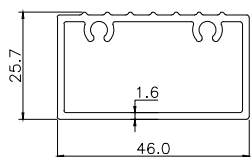

**C3319**

W = 0,689 Kg/m

T = 1,6 mm

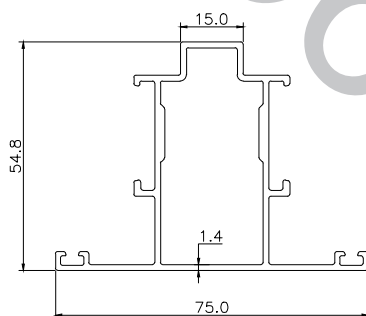

**C3313**

W = 1,002 Kg/m

T = 1,4 mm

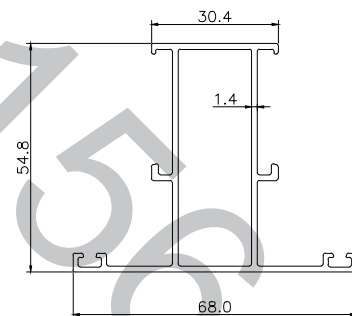

**C3204**

W = 0,880 Kg/m

T = 1,4 mm

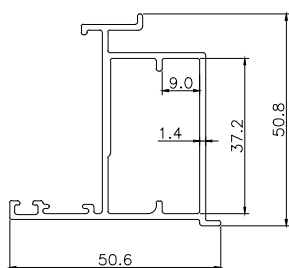

**C3208**

W = 0,760 Kg/m

T = 1,4 mm

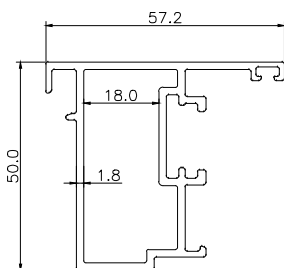

**C3323**

W = 1,086 Kg/m

T = 1,8 mm

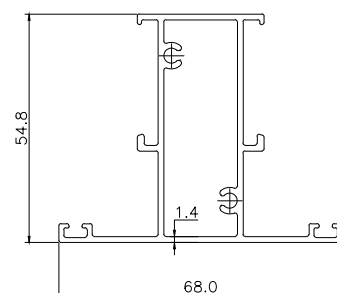

**C3203**

W = 0,950 Kg/m

T = 1,4 mm



**CÔNG TY CP NHÔM VIỆT PHÁP SHAL**  
**NHÀ MÁY NHÔM VIỆT PHÁP**

Địa chỉ: Lô KT, KCN Phúc Sơn, Đường Trần Nhân Tông, Thành phố Ninh Bình, Việt Nam  
Điện thoại: 024.8587 7979 / 0915156156 - http://nhomvietphap.biz

**HỆ THỐNG**  
**NHÔM**

**CỬA ĐI XINGFA 55**

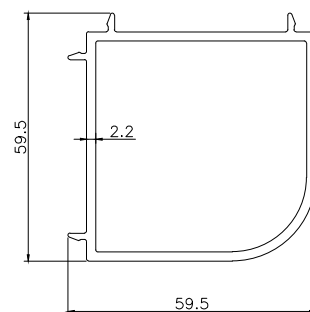
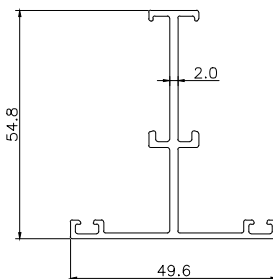
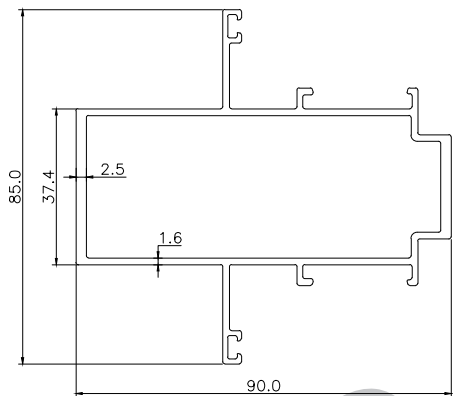

**C3315**

W = 1,558 Kg/m  
T = 1,6 mm

**C3205**

W = 0,628 Kg/m  
T = 2,0 mm

**C3326**

W = 1,275 Kg/m  
T = 2,2 mm

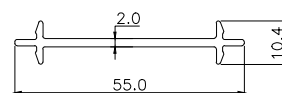
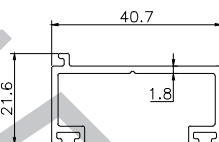
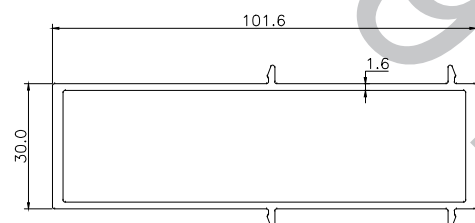

**C3329**

W = 0,428 Kg/m  
T = 1,8 mm

**C3300**

W = 0,347 Kg/m  
T = 2,0 mm

**C3310**

W = 1,308 Kg/m  
T = 1,6 mm

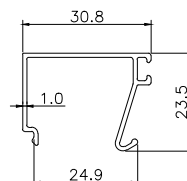
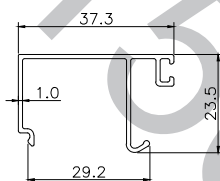
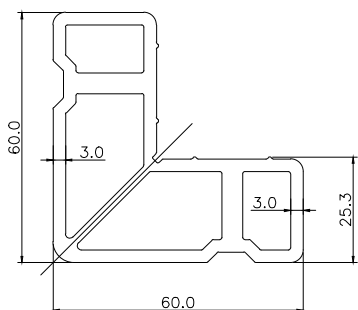

**C3295**

W = 0,271 Kg/m  
T = 1,0 mm

**C3296**

W = 0,237 Kg/m  
T = 1,0 mm

**C1697**

W = 2,437 Kg/m  
T = 3,0 mm

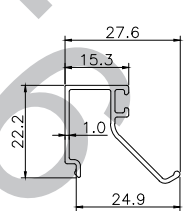
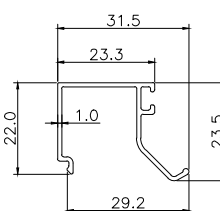

**C3286**

W = 0,223 Kg/m  
T = 1,0 mm

**C3291**

W = 0,206 Kg/m  
T = 1,0 mm

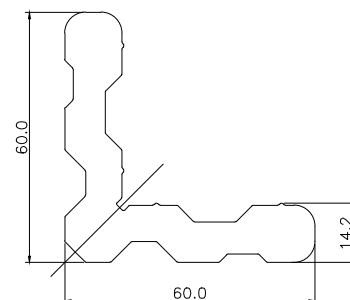
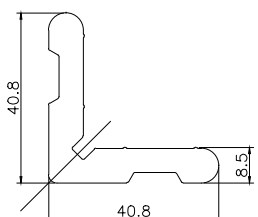
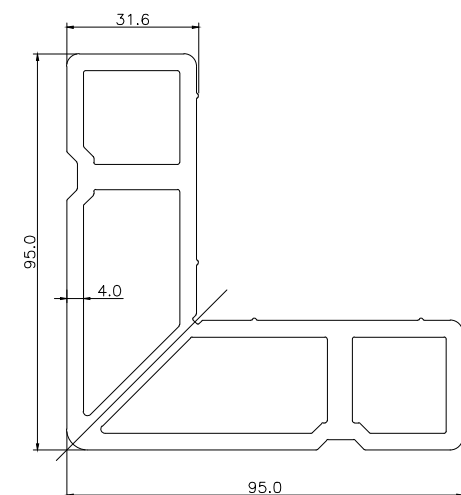

**F347**

W = 4,958 Kg/m  
T = 4,0 mm

**107**

W = 1,414 Kg/m  
T = 8,5 mm

**1687**

W = 3,134 Kg/m  
T = 14,2 mm



**CÔNG TY CP NHÔM VIỆT PHÁP SHAL  
NHÀ MÁY NHÔM VIỆT PHÁP**

Địa chỉ: Lô KT, KCN Phúc Sơn, Đường Trần Nhân Tông, Thành phố Ninh Bình, Việt Nam  
Điện thoại : 024.8587 7979 / 0915156156 - <http://nhomvietphap.biz>

**HỆ THỐNG  
NHÔM**

**CỬA ĐI XINGFA 55**

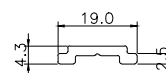
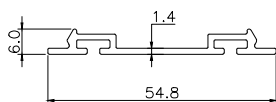
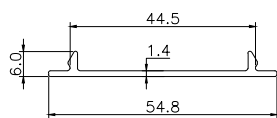

**C55.01**

W = 0.250 Kg/m  
T = 1,4 mm

**C55.02**

W = 0.314 Kg/m  
T = 1.4 mm

**C459**

W = 0.139 Kg/m  
T = 2.5 mm

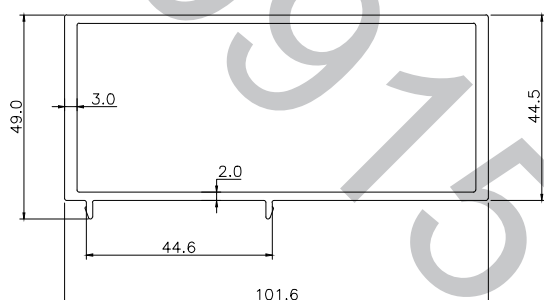

**C3740B**

W = 1.788 Kg/m  
T = 2.0 - 3.0 mm

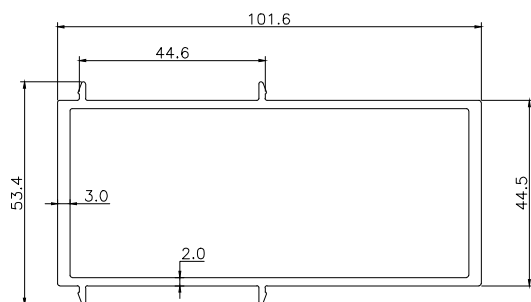

**C3740**

W = 1.822 Kg/m  
T = 2.0 - 3.0 mm



**CÔNG TY CP NHÔM VIỆT PHÁP SHAL**  
**NHÀ MÁY NHÔM VIỆT PHÁP**  
 Địa chỉ: Lô KT, KCN Phúc Sơn, Đường Trần Nhân Tông, Thành phố Ninh Bình, Việt Nam  
 Điện thoại : 024.8587 7979 / 0915156156 - http://nhomvietphap.biz

**HỆ THỐNG NHÔM**

**CỬA ĐI - CỬA SỔ XINGFA 55 - 1.4**

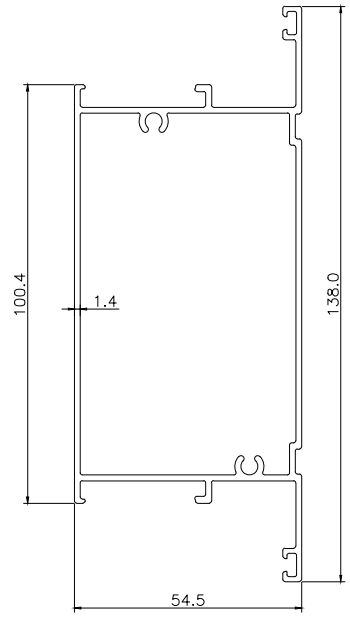
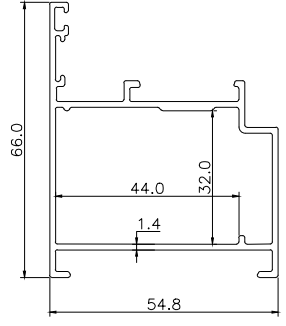
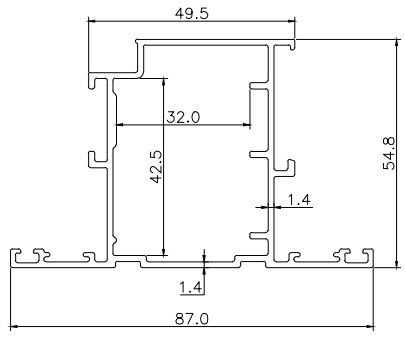

**C3303S**

W = 1,159 Kg/m  
T = 1,4 mm

**C3328S**

W = 0,960 Kg/m  
T = 1,4 mm

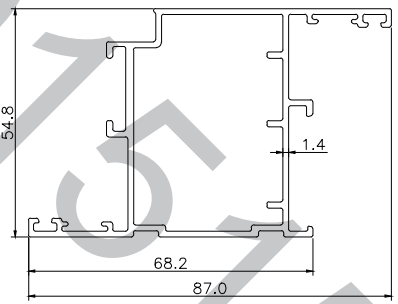
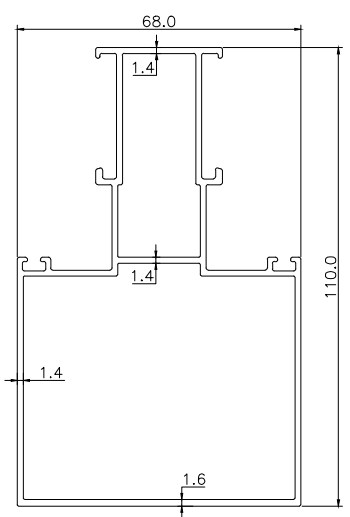

**C3332S**

W = 1,154 Kg/m  
T = 1,4 mm

**C3304S**

W = 1,506 Kg/m  
T = 1,4 mm

**C3203C**

W = 1,579 kg/m  
T = 1,4 - 1,6 mm



**CÔNG TY CP NHÔM VIỆT PHÁP SHAL  
NHÀ MÁY NHÔM VIỆT PHÁP**

Địa chỉ: Lô KT, KCN Phúc Sơn, Đường Trần Nhân Tông, Thành phố Ninh Bình, Việt Nam  
Điện thoại: 024.8587 7979 / 0915156156 - http://nhomvietphap.biz

**HỆ THỐNG  
NHÔM**

**CỬA ĐI XINGFA 55 -  
1,2**

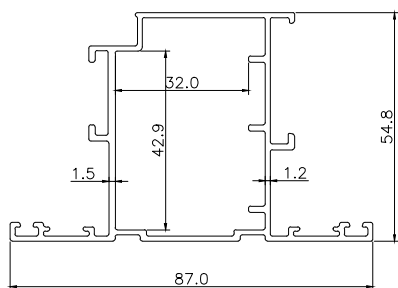

**C3303B**

W = 1,053 kg/m

T = 1,2 mm

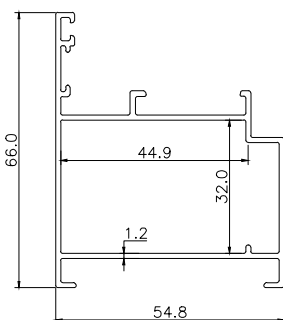

**C3328B**

W = 0,814 kg/m

T = 1,2 mm

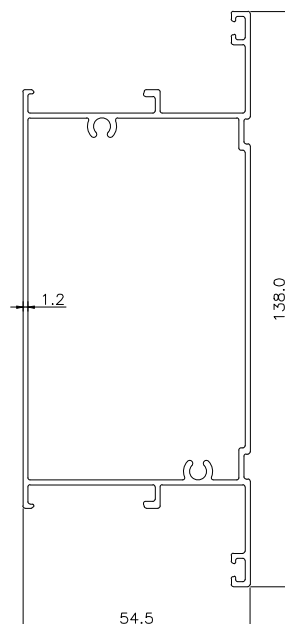

**C3304B**

W = 1,331 kg/m

T = 1,2 mm

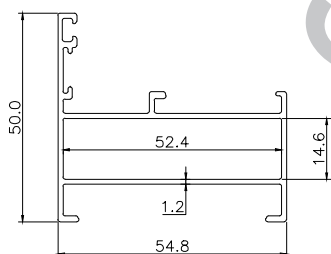

**C3209B**

W = 0,707 kg/m

T = 1,2 mm

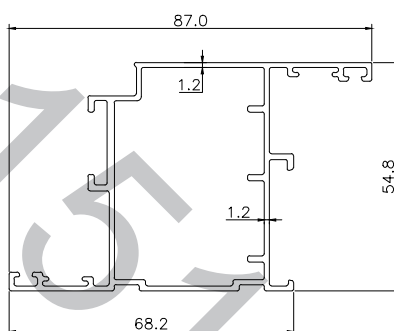

**C3332B**

W = 1,035 kg/m

T = 1,2 mm

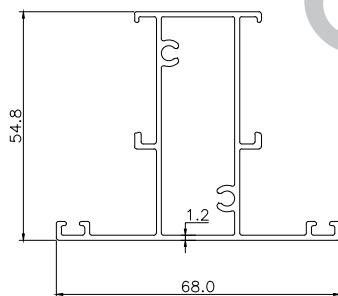

**C3203B**

W = 0,849 kg/m

T = 1,2 mm

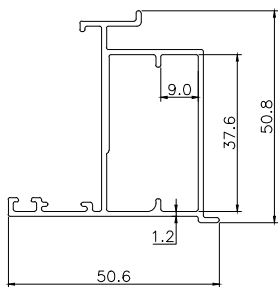

**C3208B**

W = 0,672 kg/m

T = 1,2 mm

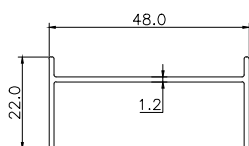

**E1283**

W = 0,290 kg/m

T = 1,2 mm

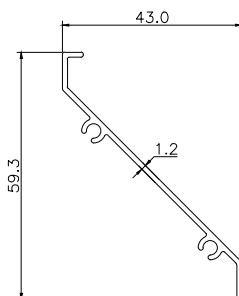

**E192**

W = 0,316 kg/m

T = 1,2 mm



**CÔNG TY CP NHÔM VIỆT PHÁP SHAL  
NHÀ MÁY NHÔM VIỆT PHÁP**

Địa chỉ: Lô KT, KCN Phúc Sơn, Đường Trần Nhân Tông, Thành phố Ninh Bình, Việt Nam  
Điện thoại: 024.8587 7979 / 0915156156 - http://nhomvietphap.biz

**HỆ THỐNG  
NHÔM**

**CỬA LÙA  
XINGFA93/2001**

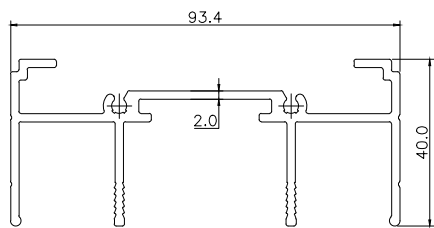

**D1541**

W = 1,459 kg/m  
T = 2,0 mm

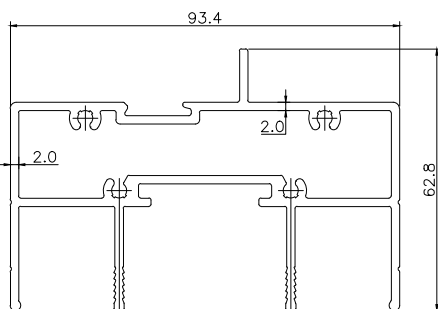

**D1551**

W = 2,164 kg/m  
T = 2,0 mm

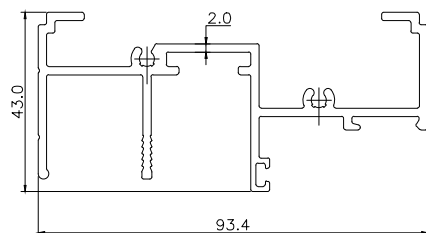

**D5061**

W = 1,461 kg/m  
T = 2,0 mm

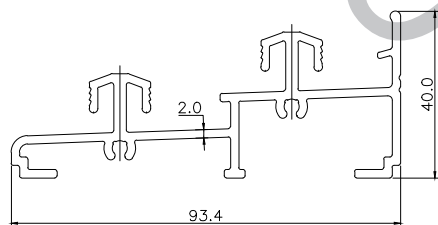

**D1942**

W = 1,561kg/m  
T = 2,0 mm

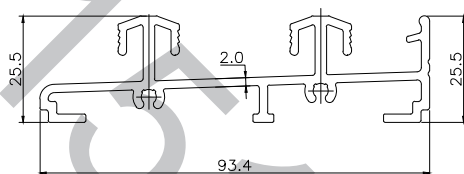

**D1942A**

W = 1,412 kg/m  
T = 2,0 mm

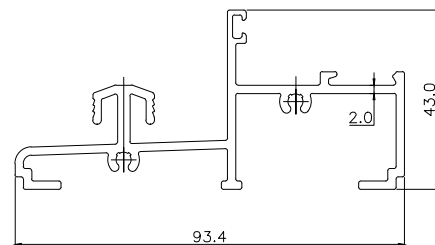

**D5062**

W = 1,395 kg/m  
T = 2,0 mm

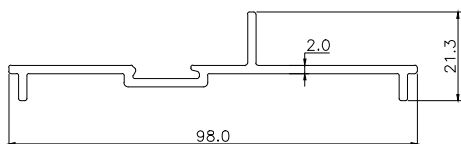

**D1549**

W = 0,712 kg/m  
T = 2,0 mm

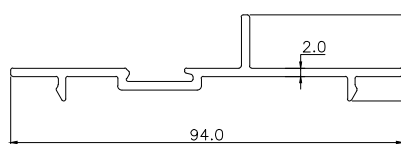

**D1578**

W = 0,676 kg/m  
T = 2,0 mm

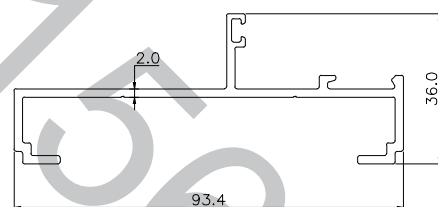

**D5059**

W = 0,927 kg/m  
T = 2,0 mm

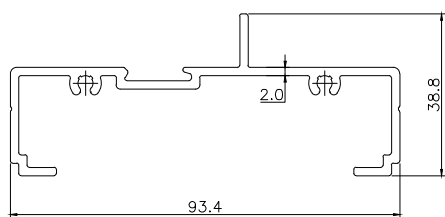

**D1559**

W = 1,070 kg/m  
T = 2,0 mm

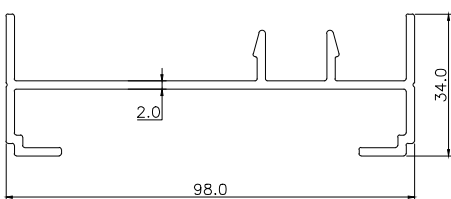

**D1543**

W = 1,134 kg/m  
T = 2,0 mm

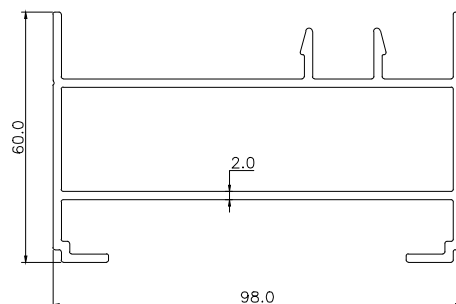

**D1553**

W = 1,923 Kg/m  
T = 2,0 mm



**CÔNG TY CP NHÔM VIỆT PHÁP SHAL  
NHÀ MÁY NHÔM VIỆT PHÁP**

Địa chỉ: Lô KT, KCN Phúc Sơn, Đường Trần Nhân Tông, Thành phố Ninh Bình, Việt Nam  
Điện thoại: 024.8587 7979 / 0915156156 - http://nhomvietphap.biz

**HỆ THỐNG  
NHÔM**

**CỬA LỬA  
XINGFA93/2001**

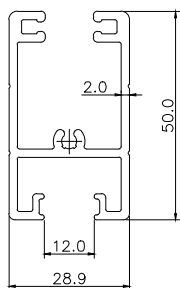

**D1544**

W = 0,991 kg/m

T = 2,0 mm

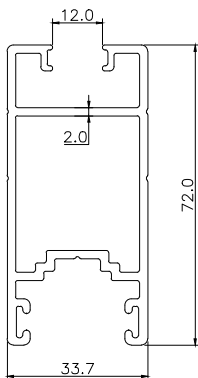

**D9006**

W = 1,381 kg/m

T = 2,0 mm

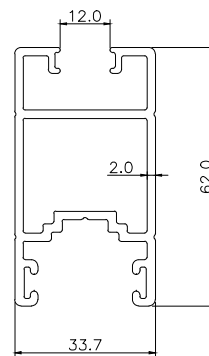

**D1546**

W = 1,273 kg/m

T = 2,0 mm

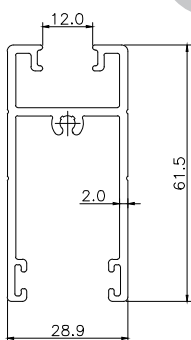

**D1545**

W = 0,999 kg/m

T = 2,0 mm

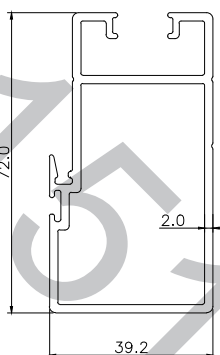

**D9007**

W = 1,335 kg/m

T = 2,0 mm

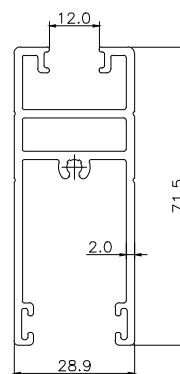

**D1555**

W = 1,243 kg/m

T = 2,0 mm

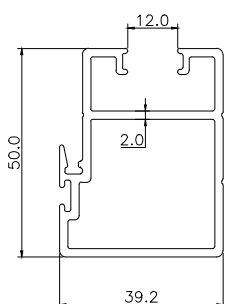

**D1547**

W = 1,098 kg/m

T = 2,0 mm

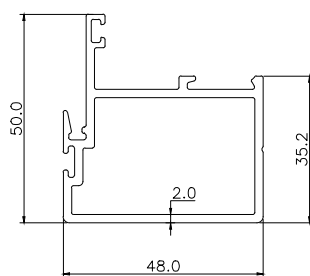

**D5067**

W = 1,024 kg/m

T = 2,0 mm

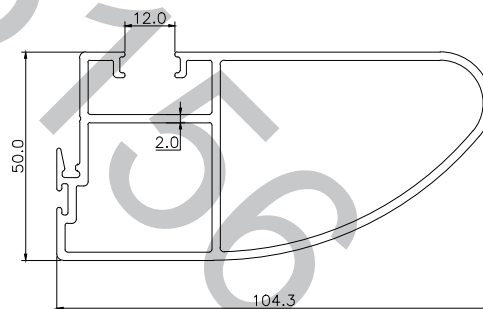

**D1637**

W = 1,906 kg/m

T = 2,0 mm

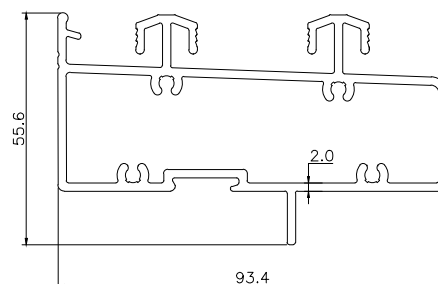

**D1942C**

W = 2.064 Kg/m

T = 2.0 mm



**CÔNG TY CP NHÔM VIỆT PHÁP SHAL  
NHÀ MÁY NHÔM VIỆT PHÁP**

Địa chỉ: Lô KT, KCN Phúc Sơn, Đường Trần Nhân Tông, Thành phố Ninh Bình, Việt Nam  
Điện thoại: 024.8587 7979 / 0915156156 - http://nhomvietphap.biz

**HỆ THỐNG  
NHÔM**

**CỬA LÙA  
XINGFA93/200I**

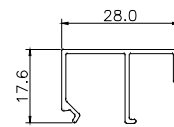
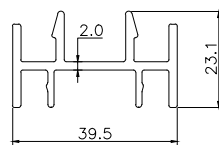
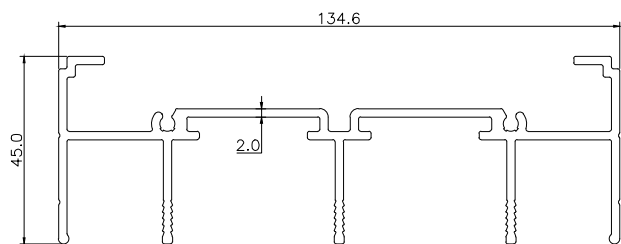

**D3211**

W = 1.959 kg/m  
T = 2.0 mm

**D1548**

W = 0,620 kg/m  
T = 2,0 mm

**C201**

W = 0,197 kg/m  
T = 1,0 mm

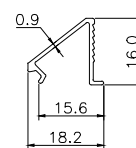
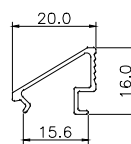
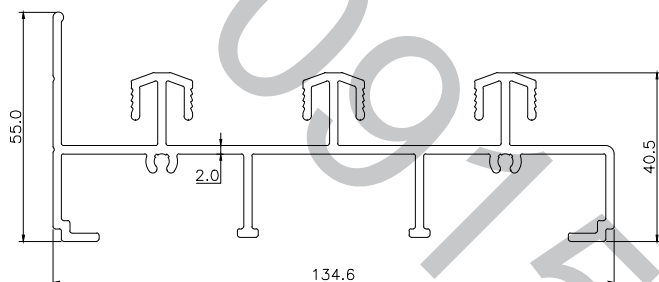

**D3212**

W = 2.295 kg/m  
T = 2.0 mm

**C101**

W = 0,133 kg/m  
T = 0,9 mm

**C101A**

W = 0.112 Kg/m  
T = 0.9 mm

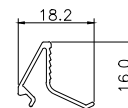
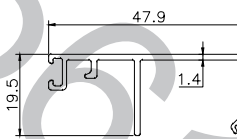
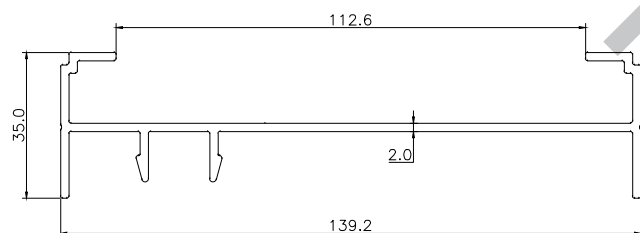

**D3213**

W = 1,367 kg/m  
T = 2.0 mm

**D5070**

W = 0,370 kg/m  
T = 1,4 mm

**D1779**

W = 0,100 kg/m  
T = 0,8 mm

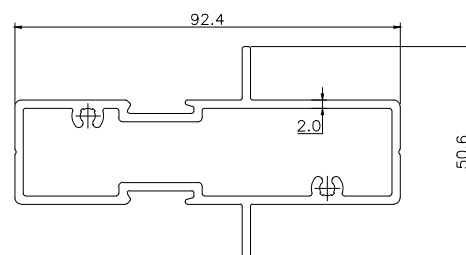
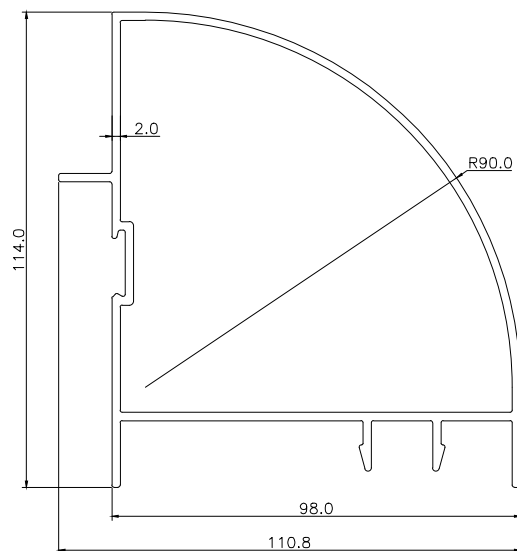

**D2490**

W = 2,292 kg/m  
T = 2,0 mm

**D2618**

W = 1,546 kg/m  
T = 2,0 mm



**CÔNG TY CP NHÔM VIỆT PHÁP SHAL  
NHÀ MÁY NHÔM VIỆT PHÁP**

Địa chỉ: Lô KT, KCN Phúc Sơn, Đường Trần Nhân Tông, Thành phố Ninh Bình, Việt Nam  
Điện thoại: 024.8587 7979 / 0915156156 - <http://nhomvietphap.biz>

**HỆ THỐNG  
NHÔM**

**CỬA LÙA  
XINGFA93/2001**

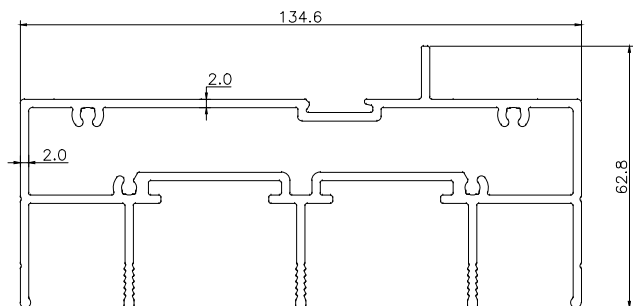

**D3211A**  
W = 2.834 kg/m  
T = 2,0 mm

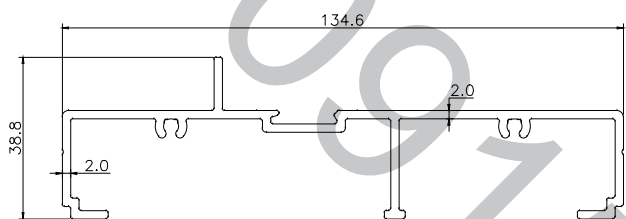

**D1559A**  
W = 1.438 Kg/m  
T = 2.0 mm

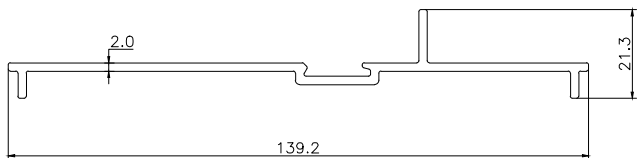

**D1549C**  
W = 0,934 Kg/m  
T = 2.0 mm

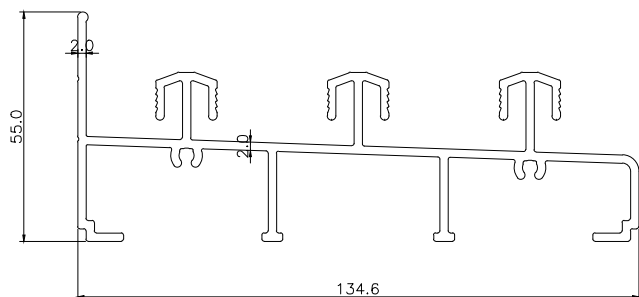

**D3212A**  
W = 2,288 Kg/m  
T = 2.0 mm



**CÔNG TY CP NHÔM VIỆT PHÁP SHAL  
NHÀ MÁY NHÔM VIỆT PHÁP**

Địa chỉ: Lô KT, KCN Phúc Sơn, Đường Trần Nhân Tông, Thành phố Ninh Bình, Việt Nam  
Điện thoại: 024.8587 7979 / 0915156156 - <http://nhomvietphap.biz>

**HỆ THỐNG  
NHÔM**

**CỬA LÙA  
XINGFA 93 - 1.4**

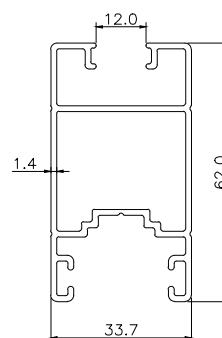
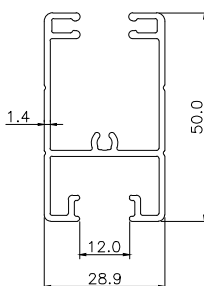
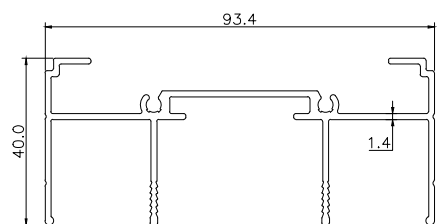

**D1541S**

W = 1,050 kg/m  
T = 1,4 mm

**D1544S**

W = 0.722 kg/m  
T = 1,4 mm

**D1546S**

W = 0.936 kg/m  
T = 1,4 mm

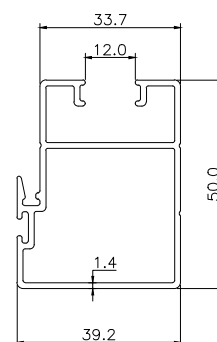
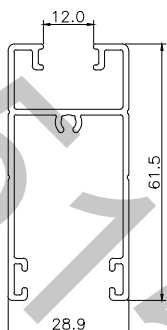
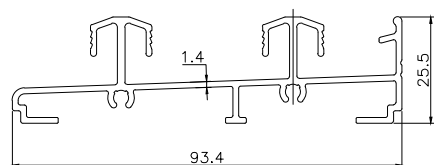

**D1942S**

W = 1,012 kg/m  
T = 1,4 mm

**D1545S**

W = 0.754 kg/m  
T = 1,4 mm

**D1547S**

W = 0.813 kg/m  
T = 1,4 mm

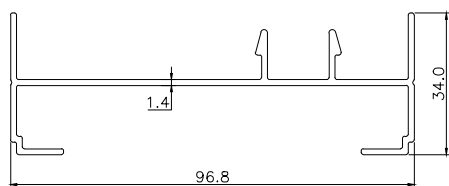

**D1543S**

W = 0,813 kg/m  
T = 1,4 mm



**CÔNG TY CP NHÔM VIỆT PHÁP SHAL  
NHÀ MÁY NHÔM VIỆT PHÁP**

Địa chỉ: Lô KT, KCN Phúc Sơn, Đường Trần Nhân Tông, Thành phố Ninh Bình, Việt Nam  
Điện thoại: 024.8587 7979 / 0915156156 - <http://nhomvietphap.biz>

**HỆ THỐNG  
NHÔM**

**CỬA LÙA  
XINGFA 93 - I.2**

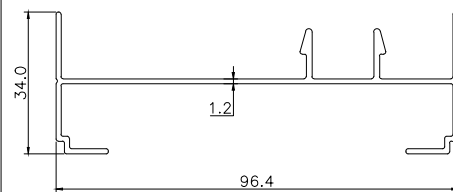
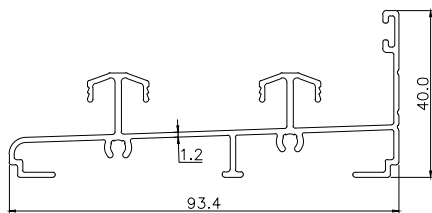
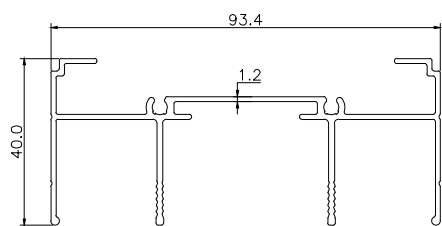

**D1541B**

W = 0,921 Kg/m

T = 1,2 mm

**D1942B**

W = 0,920 Kg/m

T = 1,2 mm

**D1543B**

W = 0,714 Kg/m

T = 1,2 mm

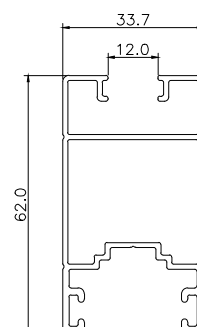
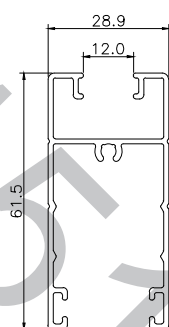
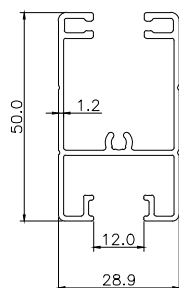

**D1544B**

W = 0,648 kg/m

T = 1,2 mm

**D1545B**

W = 0,680 kg/m

T = 1,2 mm

**D1546B**

W = 0,851 kg/m

T = 1,2 mm

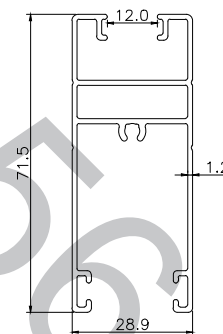
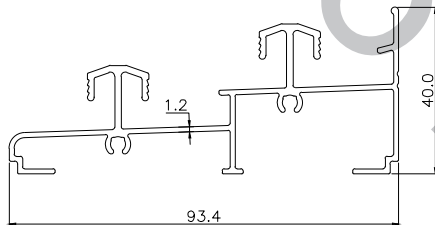
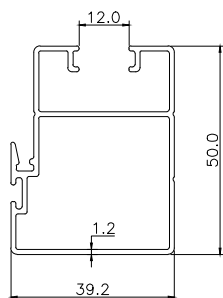

**D1547B**

W = 0,714 kg/m

T = 1,2 mm

**D1942SD**

W = 1,015 kg/m

T = 1,2 mm

**D9006SD**

W = 0,820 kg/m

T = 1,2 mm

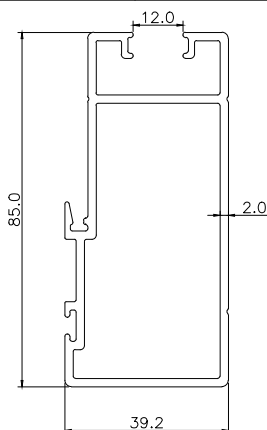
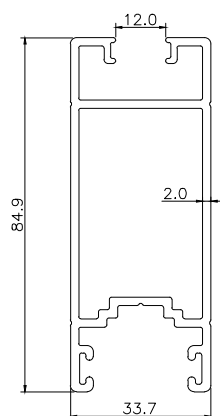

**D9009SD**

W = 1,521 kg/m

T = 2,0 mm

**D9008SD**

W = 1,494 kg/m

T = 2,0 mm



**CÔNG TY CP NHÔM VIỆT PHÁP SHAL  
NHÀ MÁY NHÔM VIỆT PHÁP**

Địa chỉ: Lô KT, KCN Phúc Sơn, Đường Trần Nhân Tông, Thành phố Ninh Bình, Việt Nam  
Điện thoại : 024.8587 7979 / 0915156156 - <http://nhomvietphap.biz>

**HỆ THỐNG  
NHÔM**

**HỆ NHÔM  
W75**

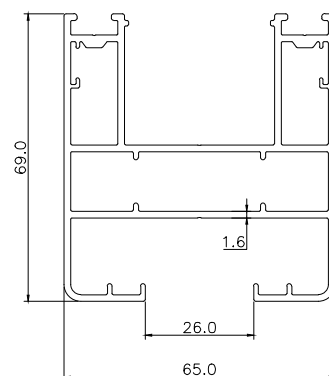
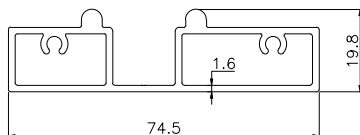
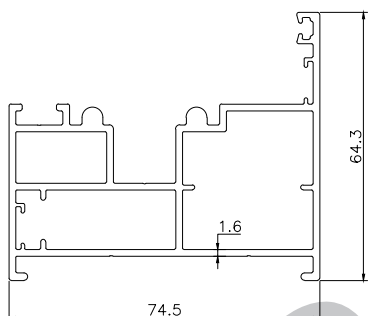

**W75.01A**

W = 1,626 Kg/m  
T = 1,6 mm

**W75.01B**

W = 0,984 Kg/m  
T = 1,6 mm

**W75.02**

W = 1,788 Kg/m  
T = 1,6 mm

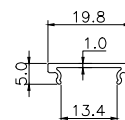
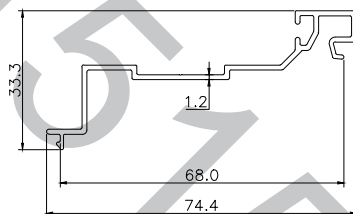
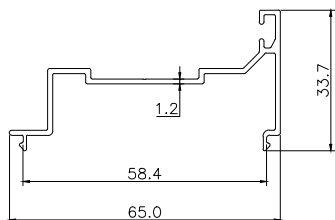

**W75.03**

W = 0,431 Kg/m  
T = 1,2 mm

**W75.04**

W = 0,422 Kg/m  
T = 1,2 mm

**W75.05**

W = 0,082 Kg/m  
T = 1,0 mm



**CÔNG TY CP NHÔM VIỆT PHÁP SHAL**  
**NHÀ MÁY NHÔM VIỆT PHÁP**

Địa chỉ: Lô KT, KCN Phúc Sơn, Đường Trần Nhân Tông, Thành phố Ninh Bình, Việt Nam  
 Điện thoại: 024.8587 7979 / 0915156156 - http://nhomvietphap.biz

**HỆ THỐNG**  
**NHÔM**

**HỆ PMA**  
**0.9-1.1MM**

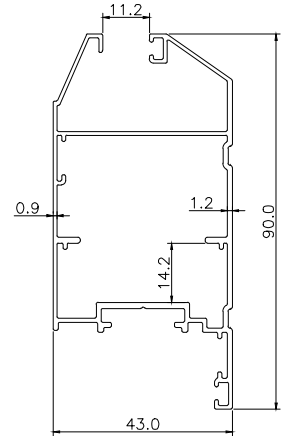
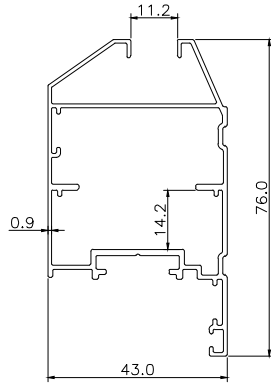
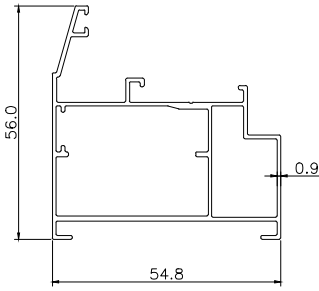

**PMA01A**

W = 0,691 Kg/m  
 T = 0,9 mm

**PMA02A**

W = 0,812 Kg/m  
 T = 0,9 - 1,1 mm

**PMA03A**

W = 0,923 Kg/m  
 T = 0,9 - 1,2 mm

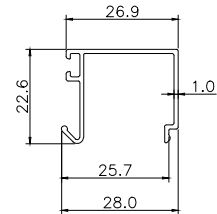
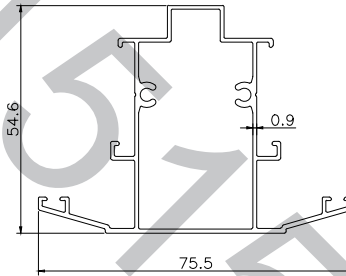
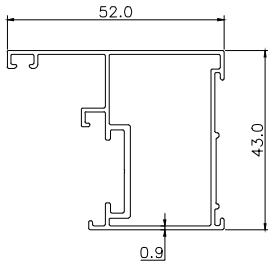

**PMA04A**

W = 0,570 Kg/m  
 T = 0,9 mm

**PMA05A**

W = 0,743 Kg/m  
 T = 0,9 mm

**PMA06A**

W = 0,219 Kg/m  
 T = 1,0 mm

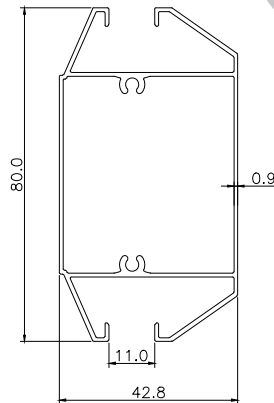
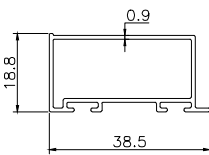

**PMA07A**

W = 0,294 Kg/m  
 T = 0,9 mm

**PMA08A**

W = 0,812 Kg/m  
 T = 0,9 mm



**CÔNG TY CP NHÔM VIỆT PHÁP SHAL**  
**NHÀ MÁY NHÔM VIỆT PHÁP**

Địa chỉ: Lô KT, KCN Phúc Sơn, Đường Trần Nhân Tông, Thành phố Ninh Bình, Việt Nam  
 Điện thoại : 024.8587 7979 / 0915156156 - http://nhomvietphap.biz

**HỆ THỐNG**  
**NHÔM**

**CỬA ĐI- CỬA SỔ**  
**HỆ PMA-1.2MM**

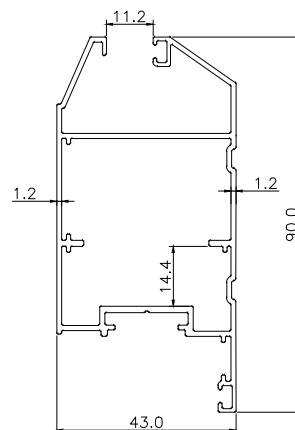
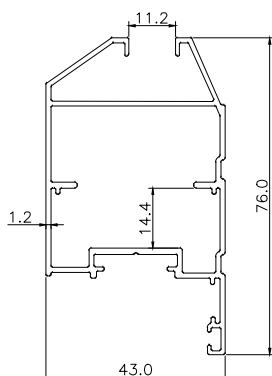
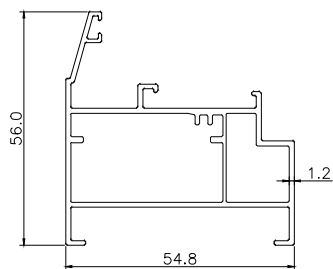

**PMA01**

W = 0,812 Kg/m  
 T = 1,2 mm

**PMA02**

W = 0.915 Kg/m  
 T = 1,2 mm

**PMA03**

W = 1.036 Kg/m  
 T = 1,2 mm

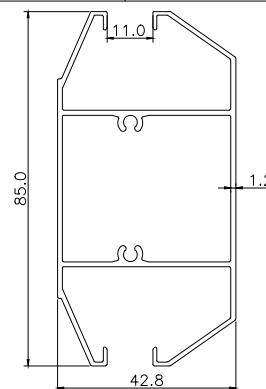
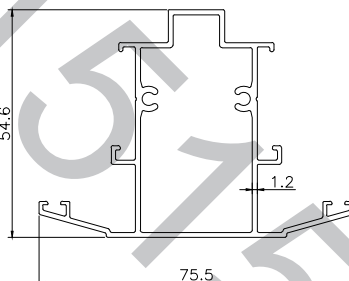
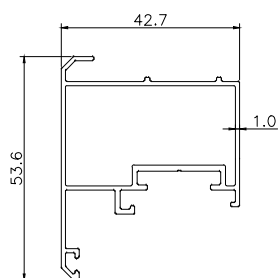

**PMA04**

W = 0.599 Kg/m  
 T = 1 mm

**PMA05**

W = 0.883 Kg/m  
 T = 1,2 mm

**PMA08**

W = 0.989Kg/m  
 T = 1,2mm



**CÔNG TY CP NHÔM VIỆT PHÁP SHAL  
NHÀ MÁY NHÔM VIỆT PHÁP**

Địa chỉ: Lô KT, KCN Phúc Sơn, Đường Trần Nhân Tông, Thành phố Ninh Bình, Việt Nam  
Điện thoại: 024.8587 7979 / 0915156156 - <http://nhomvietphap.biz>

**HỆ THỐNG  
NHÔM**

**CỬA LỬA HỆ  
PMA I-IMM**

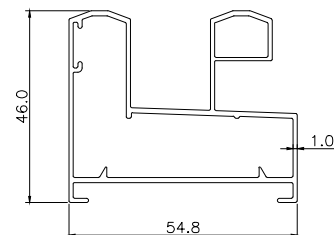
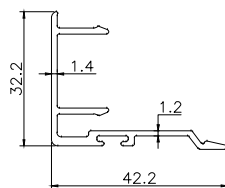
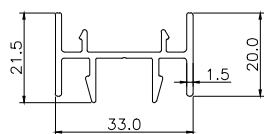

**PMA12A**

W = 0,414 Kg/m

T = 1,5 mm

**PMA11A**

W = 0,408 Kg/m

T = 1,4 mm

**PMA09A**

W = 0,793 Kg/m

T = 1,0 mm

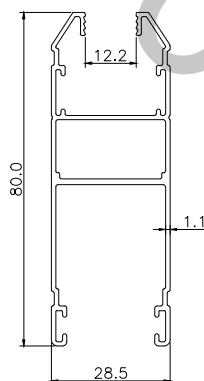

**PMA10A**

W = 0,768 Kg/m

T = 1,1 mm



**CÔNG TY CP NHÔM VIỆT PHÁP SHAL  
NHÀ MÁY NHÔM VIỆT PHÁP**

Địa chỉ: Lô KT, KCN Phúc Sơn, Đường Trần Nhân Tông, Thành phố Ninh Bình, Việt Nam  
Điện thoại: 024.8587 7979 / 0915156156 - <http://nhomvietphap.biz>

**HỆ THỐNG  
NHÔM**

**CỬA LỬA HỆ  
PMA 1.2MM**

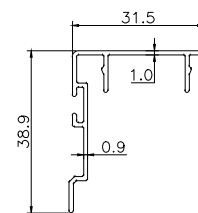
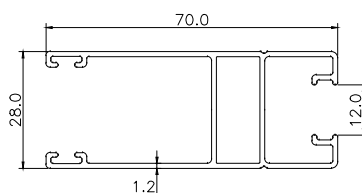
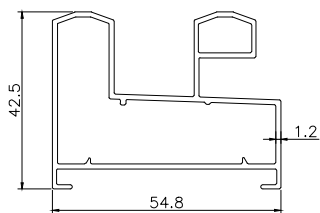

**PMA09**

W = 0.794 Kg/m

T = 1,2 mm

**PMA10**

W = 0.748 Kg/m

T = 1,2 mm

**PMA11**

W = 0.265 Kg/m

T = 1 mm

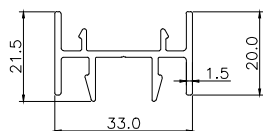

**PMA12**

W = 0,414 Kg/m

T = 1,5 mm



**CÔNG TY CP NHÔM VIỆT PHÁP SHAL**  
**NHÀ MÁY NHÔM VIỆT PHÁP**

Địa chỉ: Lô KT, KCN Phúc Sơn, Đường Trần Nhân Tông, Thành phố Ninh Bình, Việt Nam  
Điện thoại: 024.8587 7979 / 0915156156 - http://nhomvietphap.biz

**HỆ THỐNG**  
**NHÔM**

**HỆ MẶT DỰNG**  
**CW56**

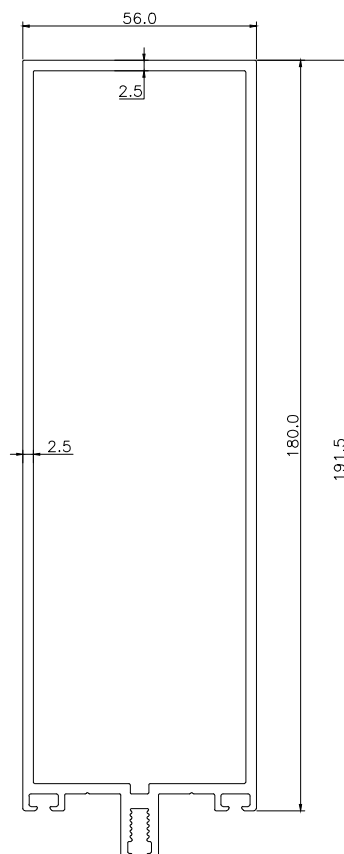
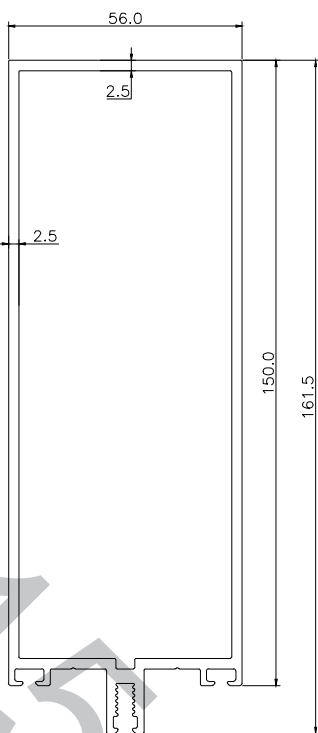
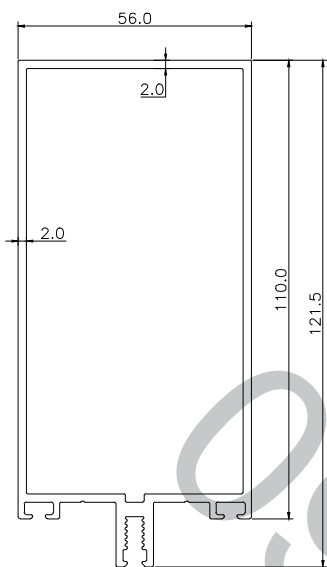

**CW5602**

W = 2,000 Kg/m

T = 2,0 mm

**CW5619**

W = 2,947 Kg/m

T = 2,5 mm

**CW5603**

W = 3,352 Kg/m

T = 2,5 mm

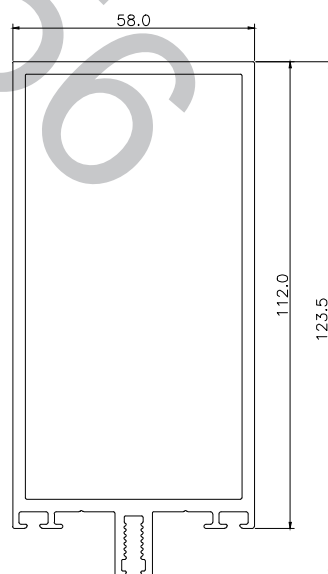
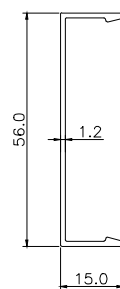
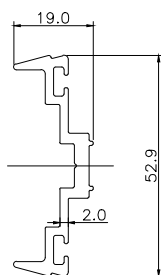
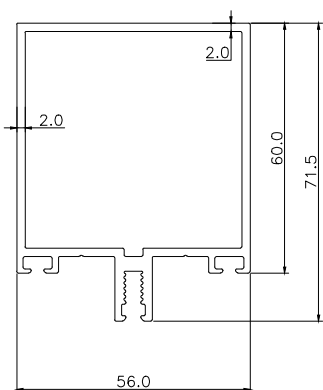

**CW5601**

W = 1,460 Kg/m

T = 2,0 mm

**CW5604**

W = 0,595 Kg/m

T = 2,0 mm

**CW5605**

W = 0,283 Kg/m

T = 1,2 mm

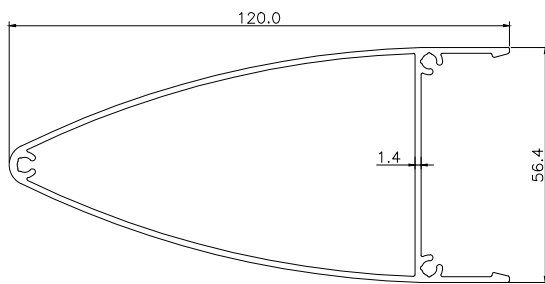
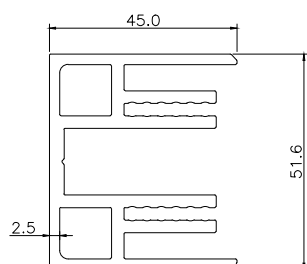

**CW5607**

W = 2,108 Kg/m

T = 2,5 mm

**CW5618**

W = 1,253 Kg/m

T = 1,4 mm

**CW5602A**

W = 2,892 Kg/m

T = 3,0 mm



**CÔNG TY CP NHÔM VIỆT PHÁP SHAL**  
**NHÀ MÁY NHÔM VIỆT PHÁP**

Địa chỉ: Lô KT, KCN Phúc Sơn, Đường Trần Nhân Tông, Thành phố Ninh Bình, Việt Nam  
Điện thoại: 024.8587 7979 / 0915156156 - http://nhomvietphap.biz

**HỆ THỐNG**  
**NHÔM**

**HỆ MẶT DỰNG**  
**CW56**

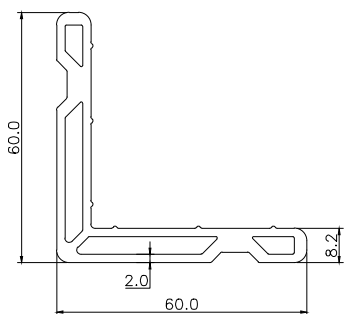

**CW5606**

W = 1,443 Kg/m

T = 2,0 mm

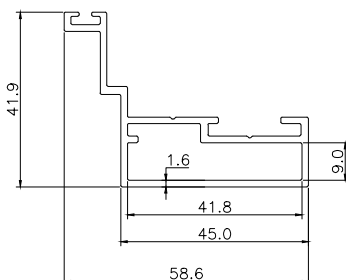

**CW5608**

W = 0,759 Kg/m

T = 1,6 mm

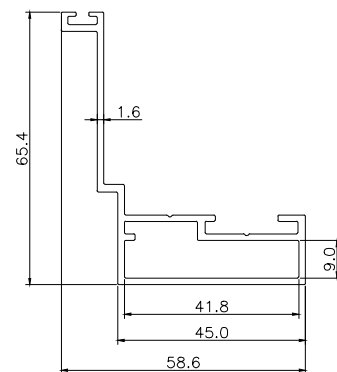

**CW5609**

W = 0,860 Kg/m

T = 1,6 mm

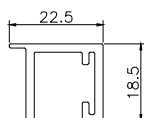

**CW5611**

W = 0,327 Kg/m

T = 2,0 mm

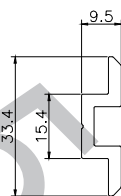

**CW5612**

W = 0,364 Kg/m

T = 3,0 mm

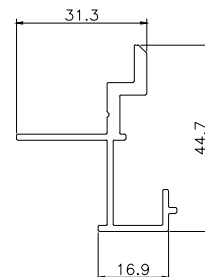

**CW5613**

W = 0,500 Kg/m

T = 1,4 mm

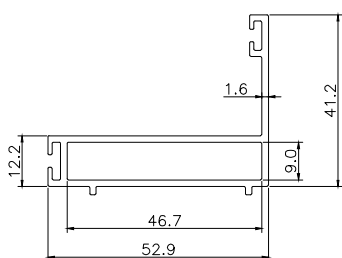

**CW5610**

W = 0,727 Kg/m

T = 1,6 mm

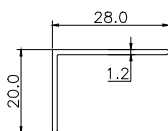

**CW5614**

W = 0,151 Kg/m

T = 1,2 mm

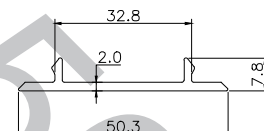

**CW5615**

W = 0,323 Kg/m

T = 2,0 mm

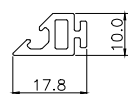

**CW5617**

W = 0,197 Kg/m

T = 1,5 mm

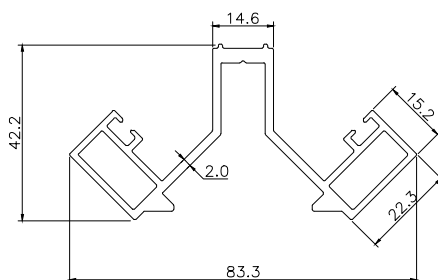

**CW5616**

W = 1,212 Kg/m

T = 2,0 mm

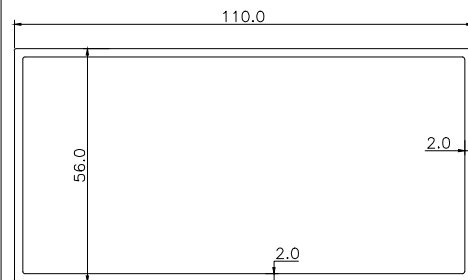

**CW5602B**

W = 1,750 Kg/m

T = 2,0 mm



**CÔNG TY CP NHÔM VIỆT PHÁP SHAL**  
**NHÀ MÁY NHÔM VIỆT PHÁP**  
 Địa chỉ: Lô KT, KCN Phúc Sơn, Đường Trần Nhân Tông, Thành phố Ninh Bình, Việt Nam  
 Điện thoại : 024.8587 7979 / 0915156156 - http://nhomvietphap.biz

**HỆ THỐNG NHÔM**

**HỆ MẶT DỰNG XINGFA 65**

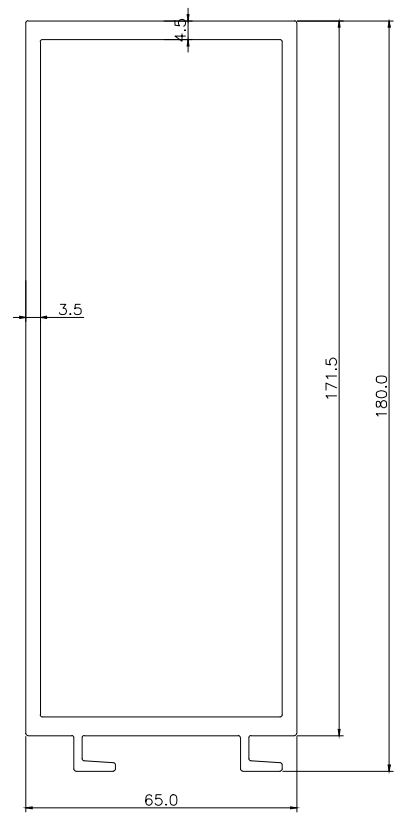
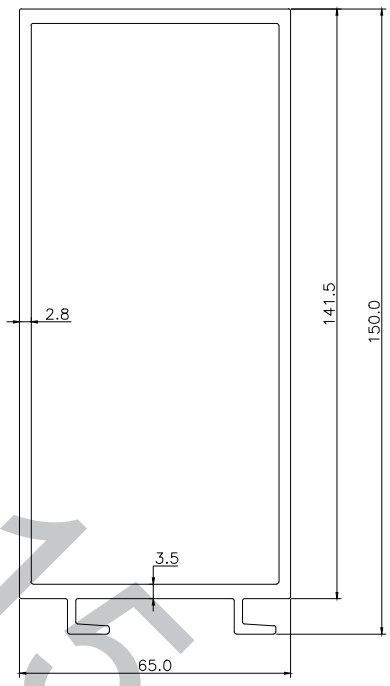
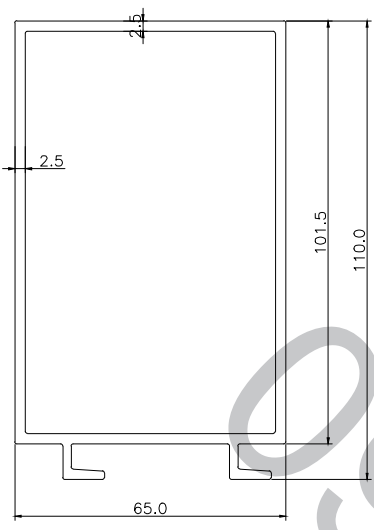

**GK021**

W = 2,369 Kg/m  
 T = 2,5 mm

**GK281**

W = 3,450 Kg/m  
 T = 2,8 mm

**GK311**

W = 4,840 Kg/m  
 T = 3,5 mm

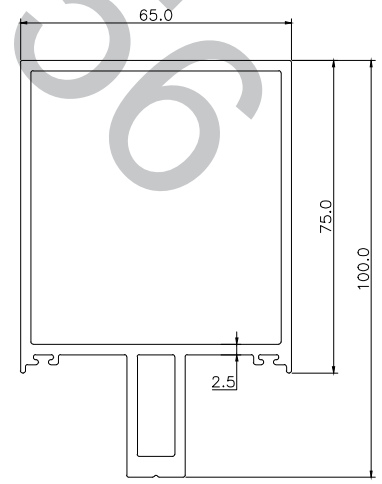
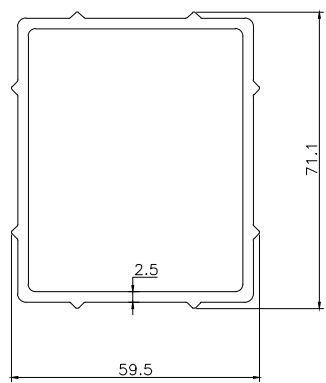
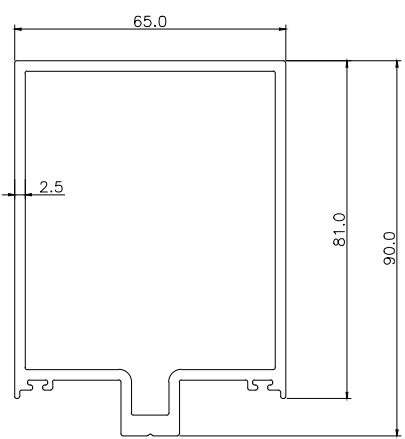

**GK471**

W = 2,159 Kg/m  
 T = 2,5 mm

**GK477**

W = 1,676 Kg/m  
 T = 2,5 mm

**GK571**

W = 2,365 Kg/m  
 T = 2,5 mm



**CÔNG TY CP NHÔM VIỆT PHÁP SHAL**  
**NHÀ MÁY NHÔM VIỆT PHÁP**

Địa chỉ: Lô KT, KCN Phúc Sơn, Đường Trần Nhân Tông, Thành phố Ninh Bình, Việt Nam  
Điện thoại: 024.8587 7979 / 0915156156 - http://nhomvietphap.biz

**HỆ THỐNG**  
**NHÔM**

**HỆ MẶT DỰNG**  
**XINGFA 65**

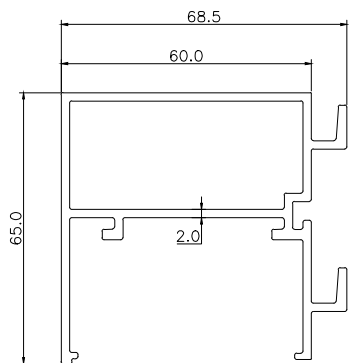

**GK813**

W = 1,629 Kg/m

T = 2,0 mm

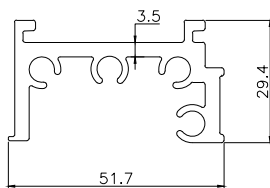

**GK1745**

W = 1.175 Kg/m

T = 3.5 mm

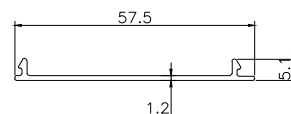

**GK413**

W = 0,215 Kg/m

T = 1,2 mm

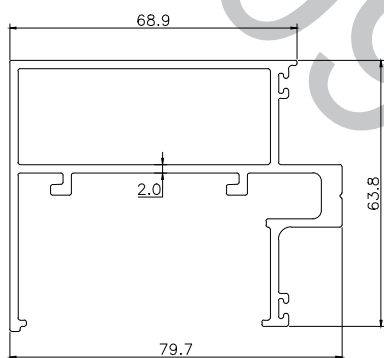

**GK993**

W = 1,803 Kg/m

T = 2,0 mm

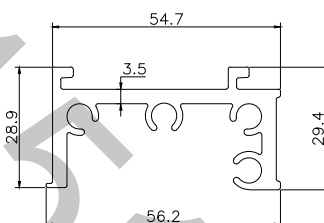

**GK865**

W = 1,218 Kg/m

T = 3,5 mm

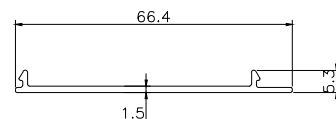

**GK1073**

W = 0,290 Kg/m

T = 1,5 mm

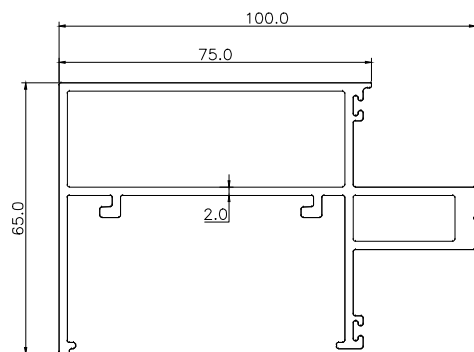

**GK1013A**

W = 2.067 Kg/m

T = 2.0 mm

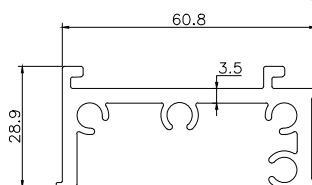

**GK865A**

W = 1.276 Kg/m

T = 3.5 mm

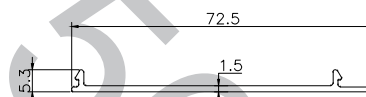

**GK1073A**

W = 0.315 Kg/m

T = 1.5 mm

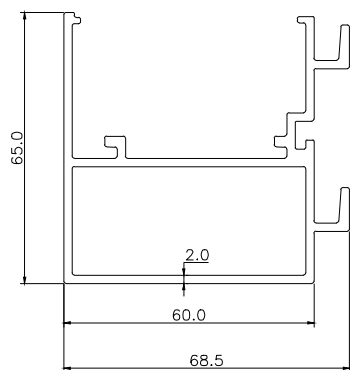

**GK853**

W = 1,650 Kg/m

T = 2,0 mm

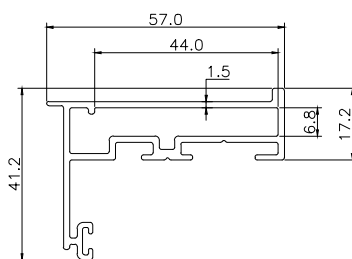

**GK1365**

W = 0,801 Kg/m

T = 1,5 mm

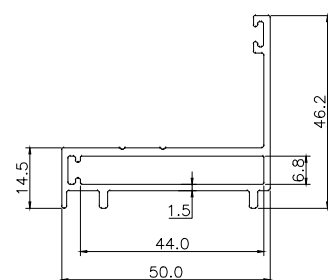

**GK1295**

W = 0,751 Kg/m

T = 1,5 mm



**CÔNG TY CP NHÔM VIỆT PHÁP SHAL**  
**NHÀ MÁY NHÔM VIỆT PHÁP**

Địa chỉ: Lô KT, KCN Phúc Sơn, Đường Trần Nhân Tông, Thành phố Ninh Bình, Việt Nam  
Điện thoại: 024.8587 7979 / 0915156156 - http://nhomvietphap.biz

**HỆ THỐNG**  
**NHÔM**

**HỆ MẶT DỰNG**  
**XINGFA 65**

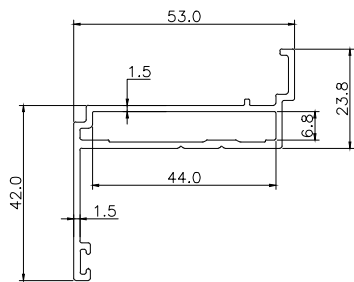

**GK1315**

W = 0,722 Kg/m

T = 1,5 mm

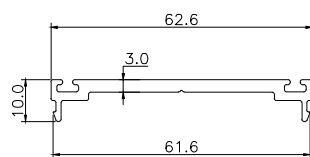

**GK015**

W = 0,577 Kg/m

T = 3,0 mm

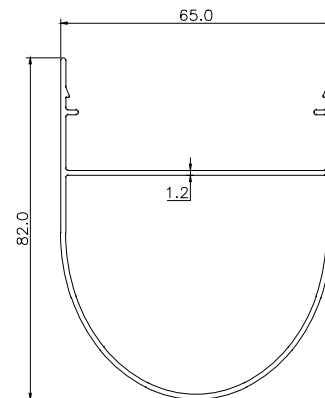

**GK126**

W = 0,865 Kg/m

T = 1,2 mm

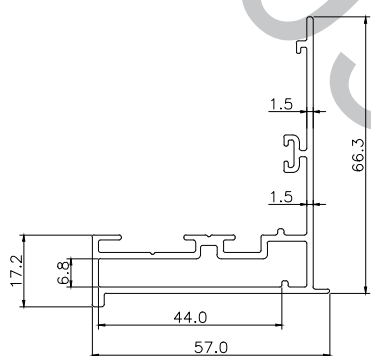

**GK1305**

W = 0,944 Kg/m

T = 1,5 mm

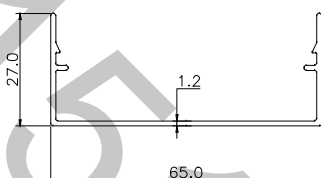

**GK066**

W = 0,404 Kg/m

T = 1,2 mm

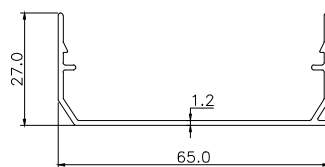

**GK086**

W = 0,399 Kg/m

T = 1,2 mm

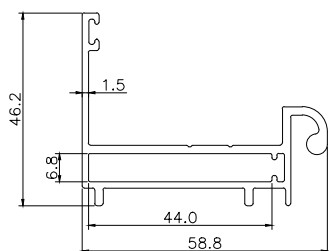

**GK1255**

W = 0,918 Kg/m

T = 1,5 mm

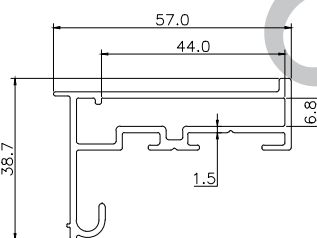

**GK1325**

W = 0,791 Kg/m

T = 1,5 mm

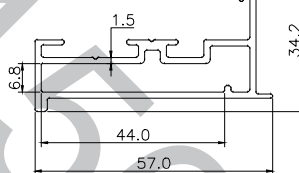

**GK2625**

W = 0,737 Kg/m

T = 1,5 mm

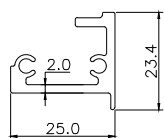

**GK208**

W = 0,382 Kg/m

T = 2,0 mm

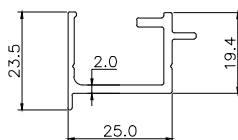

**GK348**

W = 0,375 Kg/m

T = 2,0 mm

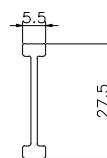

**GK805**

W = 0,176 Kg/m

T = 1,5 mm

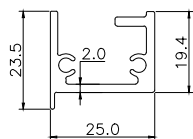

**GK218**

W = 0,437 Kg/m

T = 2,0 mm

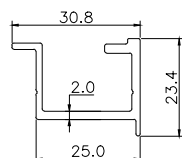

**GK358**

W = 0,370 Kg/m

T = 2,0 mm

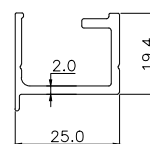

**GK228**

W = 0,356 Kg/m

T = 2,0 mm



**CÔNG TY CP NHÔM VIỆT PHÁP SHAL**  
**NHÀ MÁY NHÔM VIỆT PHÁP**

Địa chỉ: Lô KT, KCN Phúc Sơn, Đường Trần Nhân Tông, Thành phố Ninh Bình, Việt Nam  
Điện thoại: 024.8587 7979 / 0915156156 - http://nhomvietphap.biz

**HỆ THỐNG**  
**NHÔM**

**VÁCH NAN CHỚP**

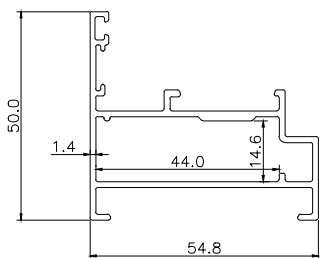

**C3318**

W = 0,845 Kg/m

T = 1,4 mm

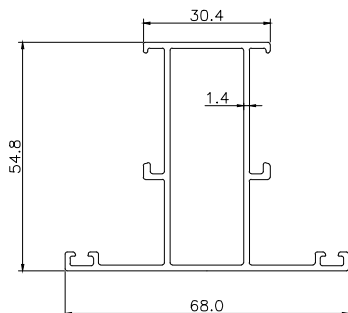

**C3204**

W = 0,880 Kg/m

T = 1,4 mm

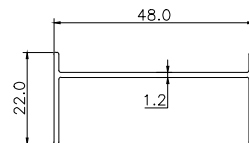

**E1283**

W = 0,290 kg/m

T = 1,2 mm

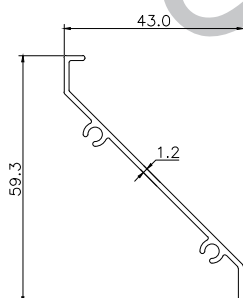

**E192**

W = 0,316 kg/m

T = 1,2 mm

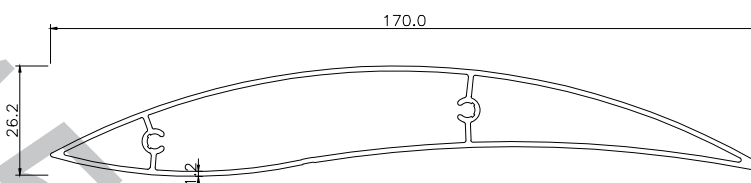

**P170**

W = 1,262 kg/m

T = 1,2 mm

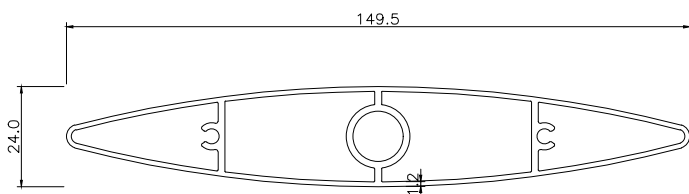

**P150x24**

W = 1,39 kg/m

T = 1,2 mm

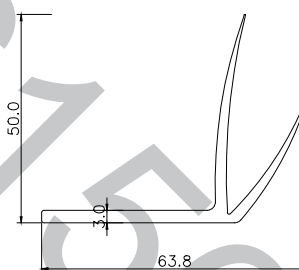

**50P150**

W = 0,769 kg/m

T = 3 mm

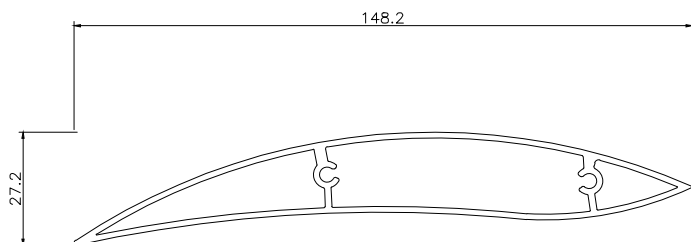

**P150**

W = 1,347 kg/m

T = 1,4 mm

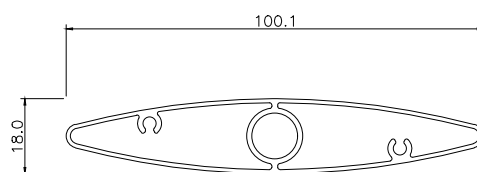

**P100X18**

W = 0,774 kg/m

T = 1 mm



**CÔNG TY CP NHÔM VIỆT PHÁP SHAL**  
**NHÀ MÁY NHÔM VIỆT PHÁP**

Địa chỉ: Lô KT, KCN Phúc Sơn, Đường Trần Nhân Tông, Thành phố Ninh Bình, Việt Nam  
Điện thoại: 024.8587 7979 / 0915156156 - http://nhomvietphap.biz

**HỆ THỐNG**  
**NHÔM**

**HỆ NHÔM**  
**W45**

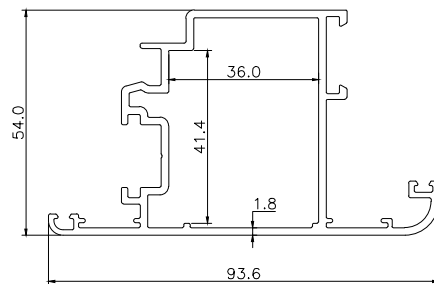
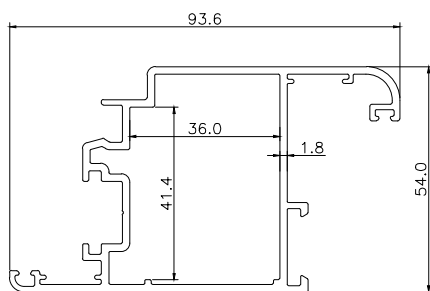
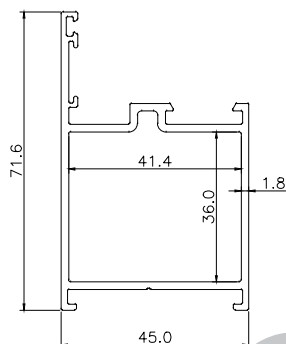

**W45.01**

W = 1,086 Kg/m  
T = 1,8 mm

**W45.02**

W = 1,475 Kg/m  
T = 1,8 mm

**W45.03**

W = 1,475 Kg/m  
T = 1,8 mm

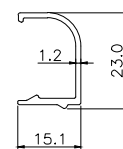
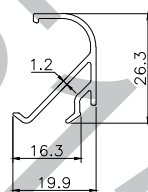
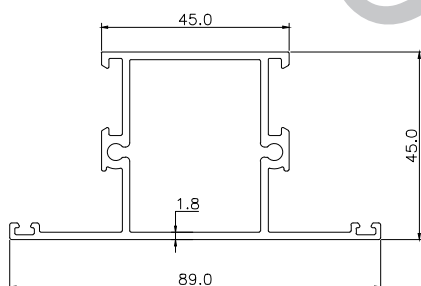

**W45.04**

W = 1,231 Kg/m  
T = 1,8 mm

**W45.06**

W = 0,229 Kg/m  
T = 1,2 mm

**W45.07**

W = 0,168 Kg/m  
T = 1,2 mm

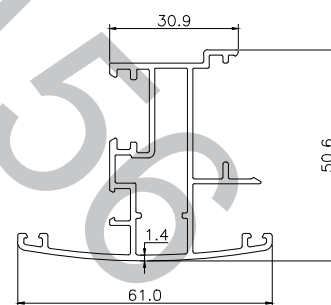
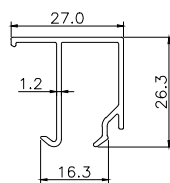
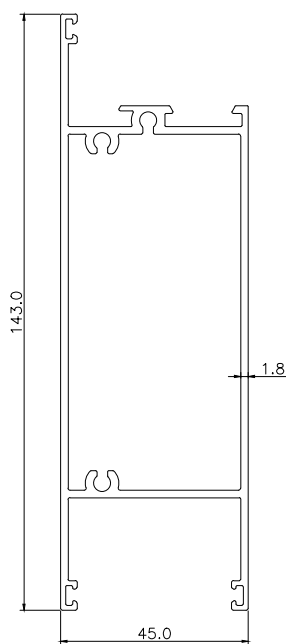

**W45.08**

W = 0,287 Kg/m  
T = 1,2 mm

**W45.09**

W = 0,911 Kg/m  
T = 1,4 mm

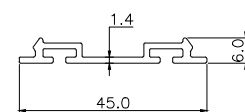
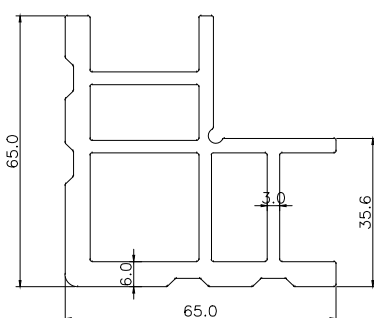

**W45.05**

W = 1,913 Kg/m  
T = 1,8 mm

**W45.10**

W = 3,252 Kg/m  
T = 3,0 - 6,0 mm

**W45.01A**

W = 0,277 Kg/m  
T = 1,4 mm



**CÔNG TY CP NHÔM VIỆT PHÁP SHAL**  
**NHÀ MÁY NHÔM VIỆT PHÁP**

Địa chỉ: Lô KT, KCN Phúc Sơn, Đường Trần Nhân Tông, Thành phố Ninh Bình, Việt Nam  
Điện thoại: 024.8587 7979 / 0915156156 - http://nhomvietphap.biz

**HỆ THỐNG**  
**NHÔM**

**HỆ NHÔM**  
**W45**

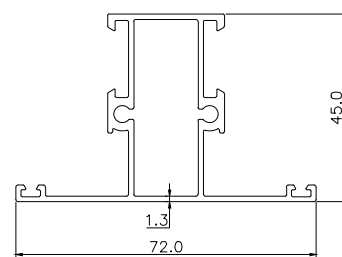
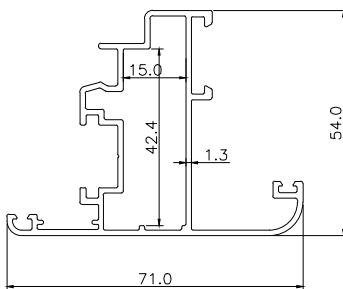
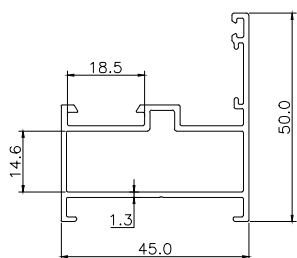

**W45.12**

W = 0,677 Kg/m  
T = 1,3 mm

**W45.13**

W = 0,972 Kg/m  
T = 1,3 mm

**W45.14**

W = 0,869 Kg/m  
T = 1,3 mm

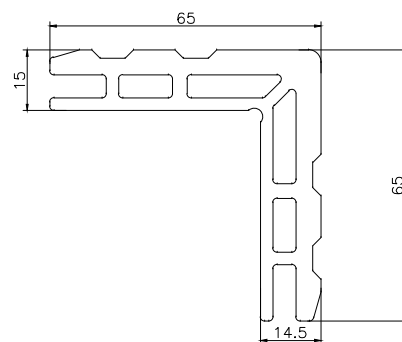
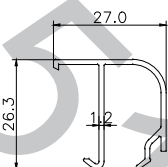
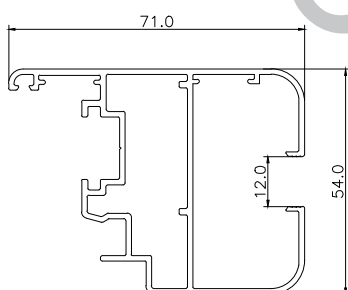

**W45.13A**

W = 1.1 Kg/m  
T = 1,4 mm

**W45.08A**

W = 0.279 Kg/m  
T = 1,2 mm

**W45.10A**

W = 2.299 Kg/m  
T = 14.5 mm

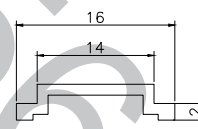
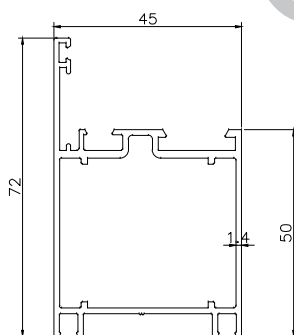
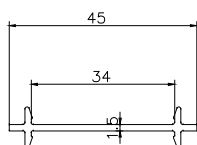

**W45.12A**

W = 0.246 Kg/m  
T = 1,5 mm

**W45.01B**

W = 0.965 Kg/m  
T = 1,4 mm

**W45.01B**

W = 0.095 Kg/m  
T = 2 mm

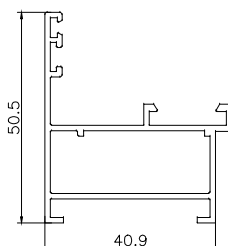
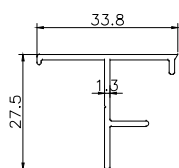

**W45.02A**

W = 0.256 Kg/m  
T = 1,3 mm

**W45.12A**

W = 0.721 Kg/m  
T = 1,4 mm



**CÔNG TY CP NHÔM VIỆT PHÁP SHAL**  
**NHÀ MÁY NHÔM VIỆT PHÁP**

Địa chỉ: Lô KT, KCN Phúc Sơn, Đường Trần Nhân Tông, Thành phố Ninh Bình, Việt Nam  
Điện thoại: 024.8587 7979 / 0915156156 - <http://nhomvietphap.biz>

**HỆ THỐNG**  
**NHÔM**

**HỆ NHÔM**  
**4400-4450**

<b>HAL4405</b>	W = 0,623 Kg/m T = 0,9 mm	<b>HAL4420</b>	W = 0,499 Kg/m T = 0,9 mm	<b>HAL5520</b>	W = 0,391 Kg/m T = 0,6 mm
<b>HAL4482A</b>	W = 0,810 Kg/m T = 1,0 mm	<b>HAL2656A</b>	W = 0,645 Kg/m T = 1,0 mm	<b>HALV4410C</b>	W = 0,805 Kg/m T = 0,9 mm
<b>HAL4451</b>	W = 0,840 Kg/m T = 0,9 mm	<b>HAL4410A</b>	W = 0,652 Kg/m T = 1,0 mm	<b>HAL450</b>	W = 0,592 Kg/m T = 1,0 mm
<b>HAL2672A</b>	W = 0,968 Kg/m T = 1,0 mm	<b>HAL5016</b>	W = 0,210 Kg/m T = 0,9 mm	<b>HAL4504</b>	W = 0,249 Kg/m T = 1,4 mm
<b>HAL4587C</b>		W = 0,302 Kg/m T = 0,9 mm		<b>HAL433</b>	
		W = 0,172 Kg/m T = 1,2 mm			



**CÔNG TY CP NHÔM VIỆT PHÁP SHAL**  
**NHÀ MÁY NHÔM VIỆT PHÁP**

Địa chỉ: Lô KT, KCN Phúc Sơn, Đường Trần Nhân Tông, Thành phố Ninh Bình, Việt Nam  
Điện thoại: 024.8587 7979 / 0915156156 - <http://nhomvietphap.biz>

**HỆ THỐNG**  
**NHÔM**

**CỬA LÙA 4400**

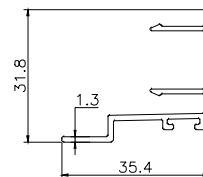
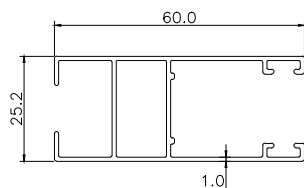
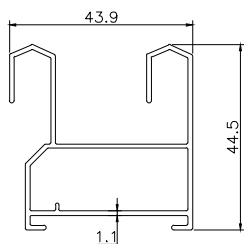

**HAL4417**  
W = 0,605 Kg/m  
T = 1,1 mm

**HAL4488**  
W = 0,544 Kg/m  
T = 1,0 mm

**HAL44M**  
W = 0,330 Kg/m  
T = 1,3 mm

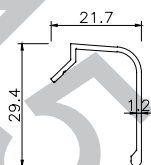
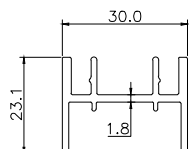

**HAL44N**  
W = 0,426 Kg/m  
T = 1,8 mm

**HAL4823**  
W = 0,176 Kg/m  
T = 1,2 mm



**CÔNG TY CP NHÔM VIỆT PHÁP SHAL**  
**NHÀ MÁY NHÔM VIỆT PHÁP**

Địa chỉ: Lô KT, KCN Phúc Sơn, Đường Trần Nhân Tông, Thành phố Ninh Bình, Việt Nam  
 Điện thoại: 024.8587 7979 / 0915156156 - http://nhomvietphap.biz

**HỆ THỐNG**  
**NHÔM**

**HỆ**  
**DẪN DỤNG**

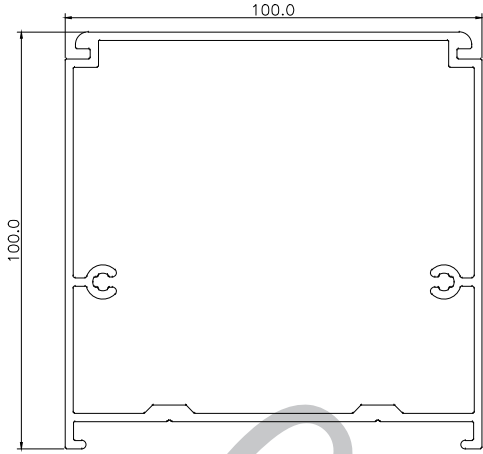

**HDLV1**

W = 2,483 Kg/m

T = 1,9 - 2,0 mm

**Bản cũ**

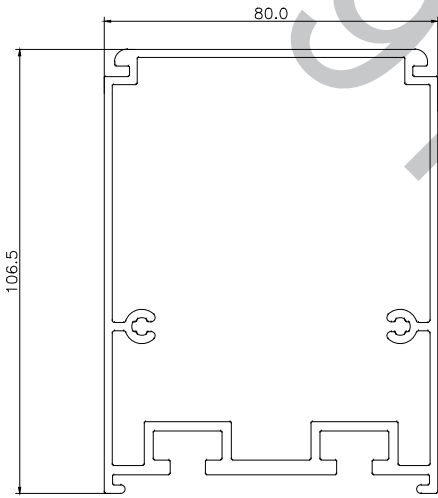

**HDLV3**

W = 2,710 Kg/m

T = 1,9 mm

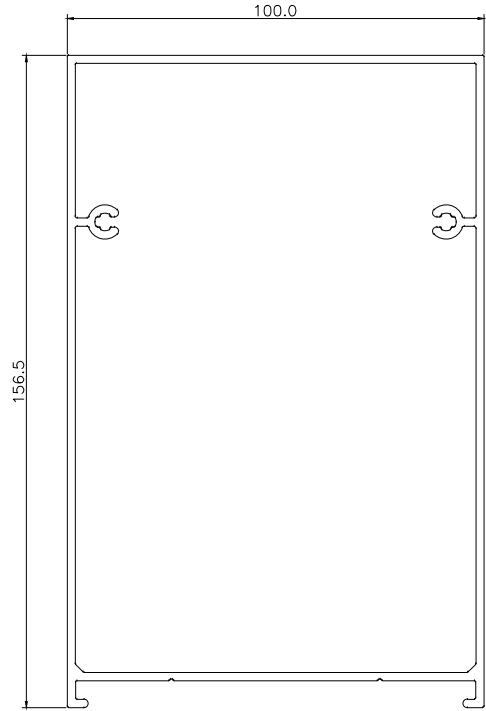

**HDLV2**

W = 2,871 Kg/m

T = 1,9 - 2,0 mm

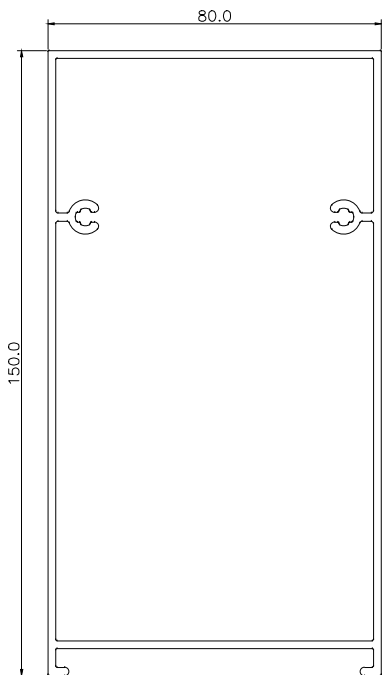

**HDLV4**

W = 2,560 Kg/m

T = 1,9 mm

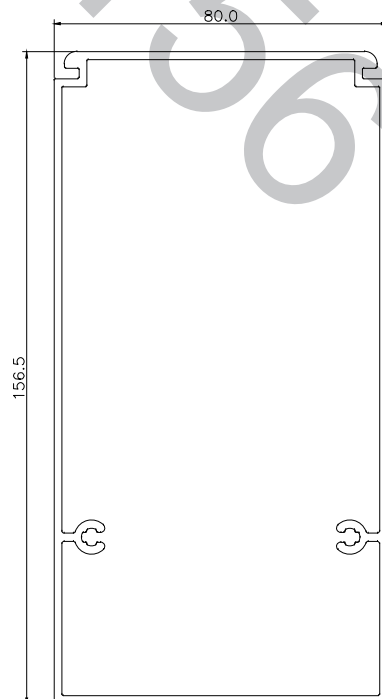

**HDLV5**

W = 2,681 Kg/m

T = 1,9 mm



**CÔNG TY CP NHÔM VIỆT PHÁP SHAL**  
**NHÀ MÁY NHÔM VIỆT PHÁP**

Địa chỉ: Lô KT, KCN Phúc Sơn, Đường Trần Nhân Tông, Thành phố Ninh Bình, Việt Nam  
Điện thoại: 024.8587 7979 / 0915156156 - <http://nhomvietphap.biz>

**HỆ THỐNG**  
**NHÔM**

**HỆ**  
**DẪN DỤNG**

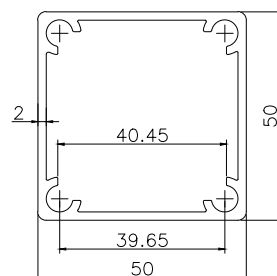
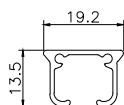
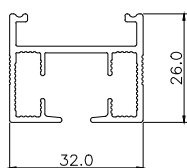

REM01

W = 0,475 Kg/m

T = 1,6 mm

REM03

W = 0,167 Kg/m

T = 1,0 - 1,1 mm

RSCH50

W = 1,195 Kg/m

T = 2,0 mm

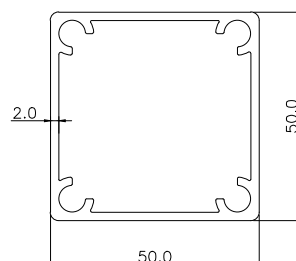
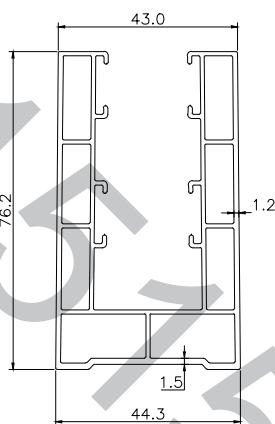
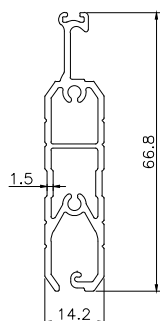

DDCC01

W = 0,712 Kg/m

T = 1,5 mm

DDCC02

W = 1,357 Kg/m

T = 1,5 mm

RSC50x50

W = 1,212 Kg/m

T = 2,0 mm

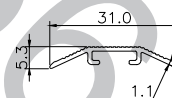
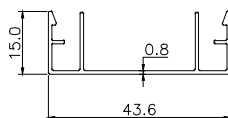
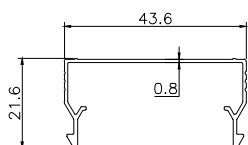

DHAN01

W = 0,220 Kg/m

T = 0,8 mm

DHAN02

W = 0,240 Kg/m

T = 0,8 mm

TGF01

W = 0,113 Kg/m

T = 1,1 mm

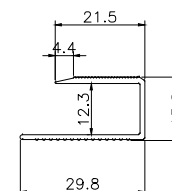
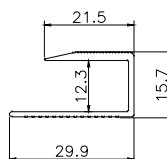
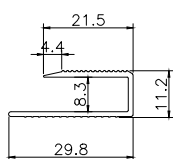

TGF03

W = 0,194 Kg/m

T = 1,15 mm

TGF02

W = 0,239 Kg/m

T = 1,3 mm

TGF02

W = 0,209 Kg/m

T = 1,15 mm



**CÔNG TY CP NHÔM VIỆT PHÁP SHAL  
NHÀ MÁY NHÔM VIỆT PHÁP**

Địa chỉ: Lô KT, KCN Phúc Sơn, Đường Trần Nhân Tông, Thành phố Ninh Bình, Việt Nam  
Điện thoại: 024.8587 7979 / 0915156156 - http://nhomvietphap.biz

**HỆ THỐNG  
NHÔM**

**HỆ  
DÂY DUNG**

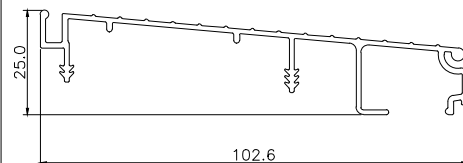
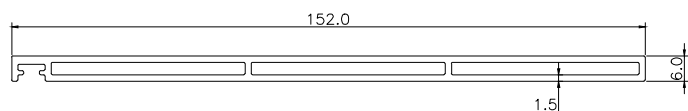

VPS001

W = 1,282 Kg/m

T = 1,5 mm

TK952

W = 0,665 Kg/m

T = 1,4 mm

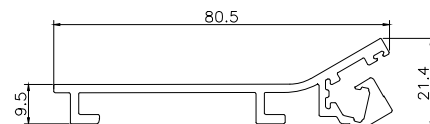
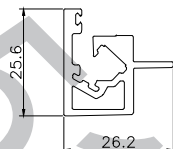
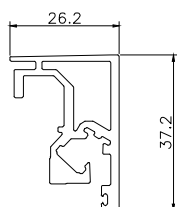

LMS7505

W = 0.717 Kg/m

T = mm

LMS7507

W = 0.528 Kg/m

T = mm

LMS7506

W = 0.836 Kg/m

T = 2 mm



**CÔNG TY CP NHÔM VIỆT PHÁP SHAL**  
**NHÀ MÁY NHÔM VIỆT PHÁP**

Địa chỉ: Lô KT, KCN Phúc Sơn, Đường Trần Nhân Tông, Thành phố Ninh Bình, Việt Nam  
 Điện thoại : 024.8587 7979 / 0915156156 - http://nhomvietphap.biz

**HỆ THỐNG**  
**NHÔM**

**HỆ**  
**DÂN DỤNG**

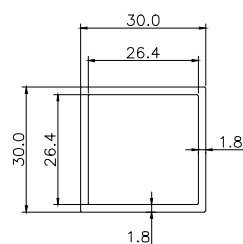
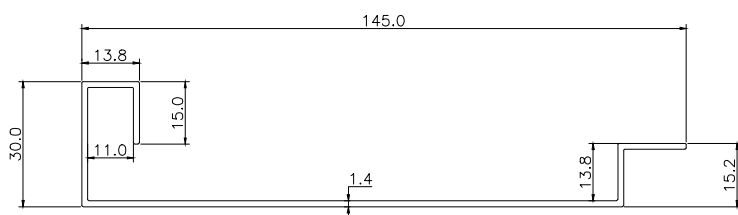

**KD2193**

W = 0,806 Kg/m

T = 1,4 mm

**H30x30F**

W = 0,548 Kg/m

T = 1,8 mm

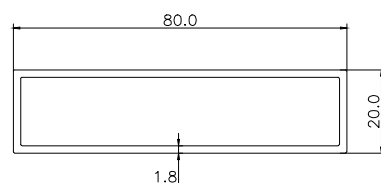
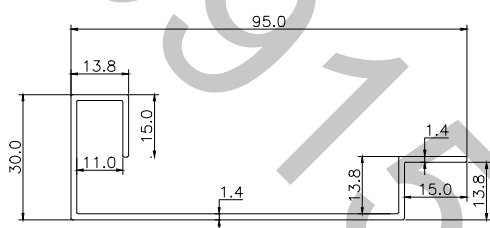

**KD994**

W = 0.617 Kg/m

T = 1,4 mm

**H20x80F**

W = 0,937 Kg/m

T = 1,8 mm

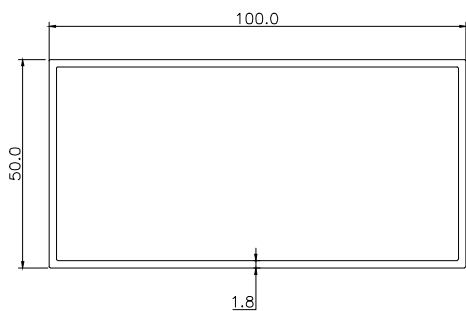

**50X100F**

W = 1,423 Kg/m

T = 1,8 mm

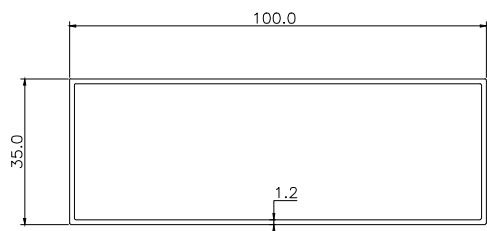
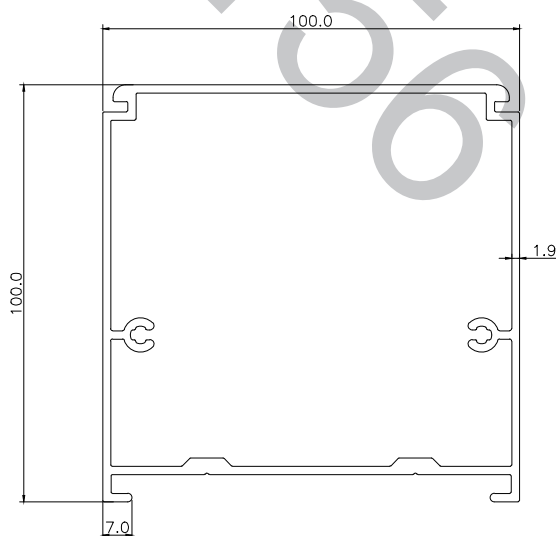

**35X100**

W = 0,859 Kg/m

T = 1,2 mm

**HDLV1**

W = 2,504 Kg/m

T = 1,9 mm



**CÔNG TY CP NHÔM VIỆT PHÁP SHAL  
NHÀ MÁY NHÔM VIỆT PHÁP**

Địa chỉ: Lô KT, KCN Phúc Sơn, Đường Trần Nhân Tông, Thành phố Ninh Bình, Việt Nam  
Điện thoại: 024.8587 7979 / 0915156156 - <http://nhomvietphap.biz>

**HỆ THỐNG  
NHÔM**

**HỆ  
DÂY DUNG**

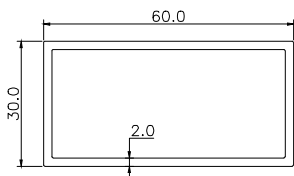

0.928

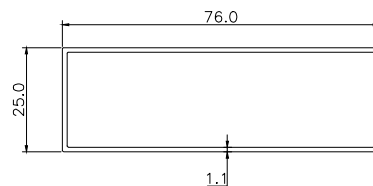
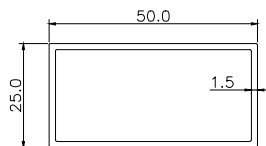

H60x30A

W = 0,928 Kg/m

T = 2 mm

H25x50A

W = 0,583 Kg/m

T = 1,5 mm

76X25

W = 0,587 Kg/m

T = 1,1 mm

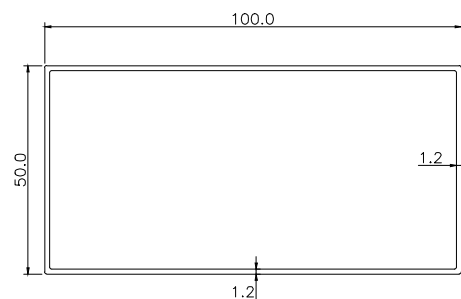
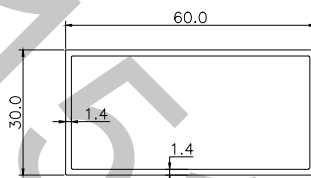
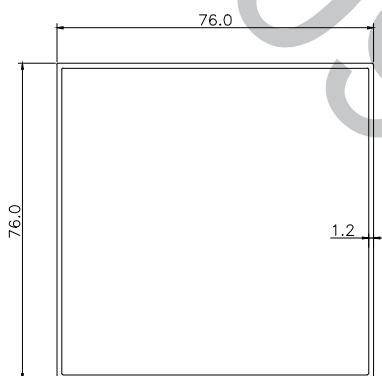

76x76

W = 0,969 Kg/m

T = 1,2 mm

60x30

W = 0,659 Kg/m

T = 1,4 mm

H50x100

W = 0,956 Kg/m

T = 1,2 mm

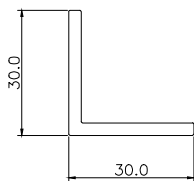

V3030

W = 0,461 Kg/m

T = 3,0 mm